

SOKKIA

SDG1
DUAL GRADE LASER

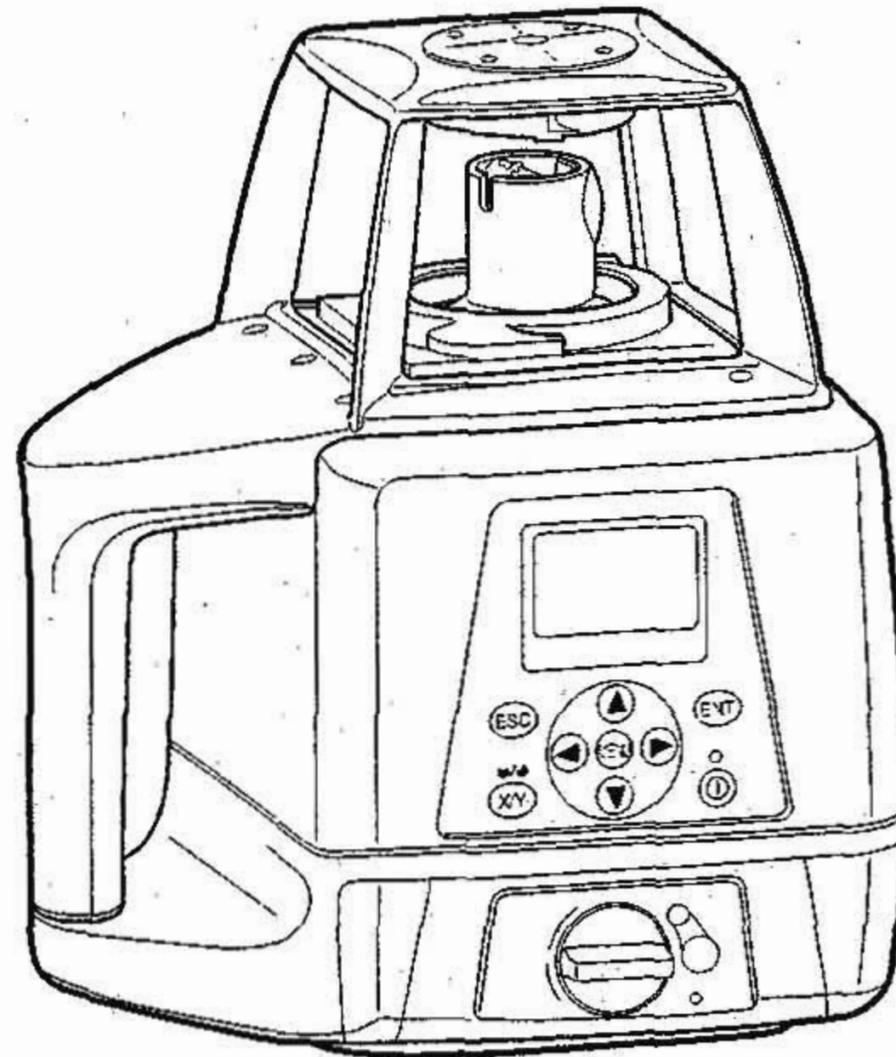

Class 3R Laser Product

OPERATOR'S MANUAL



- [English] CONTAIN NI-MH BATTERY. CADMIUM-FREE. MUST BE RECYCLED OR DISPOSED OF PROPERLY.
- [Deutsch] MIT NIMH AKKU. ENTHALT KEIN KADMIUM. EFORDERT RECYCLING ODER FACHGERECHTE ENTSORGUNG.
- [Français] CONTIENT UNE BATTERIE AU NI-MH. SANS CADMIUM. DOIT ÊTRE RECYCLÉE OU DONNÉE A UN ORGANISME DE RETRAITEMENT.
- [Italiano] CONTIENE NIMH BATTERIA. NON CONTIENE CADMIO. DEVE QUINDI ESSERE RICICLATA O ELIMINATA IN MODO APPROPRIATO.
- [Nederlands] BEVAT EEN NIMH BATTERIJ. BEVAT GEEN CADMIUM. DIENT GERECYCLEERD OF OP EEN CORRECTE MANIER VERNIETIGD TE WORDEN.
- [Español] CONTIENE UNA NIMH BATERÍA. NO CONTIENE CADMIO. DEBE RECICLARSE O ELIMINARSE ADECUADAMENTE.
- [Português] CONTEM BATERIA DE NIMH. SEM CÁDMIO. DEVERÁ SER RECICLADA OU DECARTEADA CONVENIENTEMENTE.
- [Svensk] INNEHÅLLER NIMH BATTERI. KÄDMIUMFRITT. BÖR ÅTERVINNAS ELLER FÖRSTÖRAS PÅ ETT SÄKERT SÄTT.
- [Suomi] SISÄLTÄÄ NIMH AKUN. HÄVITETTÄESSÄ KÄSITELTÄVÄ ONGELMAJÄTTEENÄ.
- [Norak] NIMH BATTERIER. INNEHOLDER IKKE KADMIUM. MÅ RESIRKULERES ELLER KASTES PÅ EN FORSVARLIG MÅTE.
- [Dansk] INDEHOLDER NIMH BATTERI. KADMIUMFRIT. SKAL GENVINDES ELLER KASSERES PÅ FORSVARLIG MÅDE.
- [Ελληνικά] ΠΕΡΙΕΧΕΙ ΜΠΑΤΑΡΙΑ ΝΙΚΕΛΙΟΥ-ΜΕΤΑΛΛΟΥ ΥΔΡΑΙΟΥ. ΔΕΝ ΠΕΡΙΕΧΕΙ ΚΑΔΜΙΟ. ΠΡΕΠΕΙ ΝΑ ΑΝΑΚΥΚΛΩΝΕΤΑΙ Η ΝΑ ΚΑΤΑΣΤΡΕΦΕΤΑΙ ΜΕ ΤΟΝ ΚΑΤΑΛΛΗΛΟ ΤΡΟΠΟ.

For U.S.A. ATTENTION:

The product that you have purchased contains a rechargeable battery. The battery is recyclable. At the end of its useful life, under various state and local laws, it may be illegal to dispose of this battery into the municipal waste stream. Check with your local solid waste officials for details in your area for recycling options or proper disposal. Use the standard battery charger.

Die Schweiz: Nach Gebrauch der Verkaufsstelle zurückgeben.

La Suisse: Après usage à rapporter au point de vente.

Switzerland: Ritornare la pila usata al negozio.

JSIMA

This is the mark of the Japan Surveying Instruments Manufacturers Association.

SOKKIA

SDG1
DUAL GRADE LASER

Class 3R Laser Product

OPERATOR'S MANUAL

Thank you for selecting the SDG1.

- Please read this operator's manual carefully before using this product.
- Verify that all equipment is included.
 - ☞ "Standard System Components" on page 47
- The specifications and general appearance of the instrument are subject to change without prior notice and without obligation by Sokkia Topcon Co., Ltd. and may differ from those appearing in this manual.
- The content of this manual is subject to change without notice.
- Some of the diagrams shown in this manual may be simplified for easier understanding.

Contents

Precautions for Safe Operation	1
Precautions	6
Laser Safety Information	9
Parts of the Instrument	12
Sample Display	14
Key Functions	15
SDG1 LED Display	15
Basic Operation	16
Preparation and Functions	17
Power Source	17
Setting Up Instrument	17
LRC6 Remote Controller	18
Power Switch	20
Battery Status Display	22
Setting Grades	23
Aligning Direction of Grade	24
How to Enter Grade	25
Menu	26
How to Set the Menu	26
Switching Masking Mode	28

Maintaining Power Sources	35
How to Change Batteries on the Instrument.....	35
Rechargeable battery	35
How to Replace the LRC6 Batteries	38
Checks and Adjustment	39
Horizontal Calibration	39
Horizontal Rotation Cone Error.....	43
Grade Setting Error.....	44
Storage Precautions.....	46
Standard System Components	47
Standard/Optional Accessories	48
Specifications	53
Error Display	55
Regulations	57

Precautions for Safe Operation

For the safe use of the product and prevention of injury to operators and other persons as well as prevention of property damage, items which should be observed are indicated by an exclamation point within a triangle used with WARNING and CAUTION statements in this operator's manual. The definitions of the indications are listed below. Be sure you understand them before reading the manual's main text.

Display	Meaning
 WARNING	Ignoring this indication and making an operation error could possibly result in death or serious injury to the operator.
 CAUTION	Ignoring this indication and making an operation error could possibly result in personal injury or property damage.



This symbol indicates items for which caution (hazard warnings inclusive) is urged. Specific details are printed in or near the symbol.



This symbol indicates items which are prohibited. Specific details are printed in or near the symbol.



This symbol indicates items which must always be performed. Specific details are printed in or near the symbol.

Warning

-  Do not use the unit in areas exposed to high amounts of dust or ash, in areas where there is inadequate ventilation, or near combustible materials. An explosion could occur.
-  Do not perform disassembly or rebuilding. Fire, electric shock, burns, or hazardous radiation exposure could result.
-  When securing the instrument in the carrying case make sure that all catches, including the side catches, are closed. Failure to do so could result in the instrument falling out while being carried, causing injury.

Caution

-  Do not use the carrying case as a footstool. The case is slippery and unstable so a person could slip and fall off it.
-  Do not place the instrument in a case with a damaged catch or handle. The case or instrument could be dropped and cause injury.

Power Supply



Warning



Do not place articles such as clothing on the battery charger while charging batteries. Sparks could be induced, leading to fire.



Do not use voltage other than the specified power supply voltage. Fire or electrical shock could result.



Do not use damaged power cords, plugs or loose outlets. Fire or electric shock could result.



Use only the specified battery charger to recharge batteries. Other chargers may be of different voltage rating or polarity, causing sparking which could lead to fire or burns.



Do not heat or throw batteries into fire. An explosion could occur, resulting in injury.



To prevent shorting of the battery in storage, apply insulating tape or equivalent to the terminals. Otherwise shorting could occur resulting in fire or burns.



Do not use batteries or the battery charger if wet. Resultant shorting could lead to fire or burns.



Do not connect or disconnect power supply plugs with wet hands. Electric shock could result.



Caution



Do not touch liquid leaking from batteries. Harmful chemicals could cause burns or blisters.

Tripod



Caution



When mounting the instrument to the tripod, tighten the centering screw securely. Failure to tighten the screw properly could result in the instrument falling off the tripod, causing injury.



Tighten securely the leg fixing screws of the tripod on which the instrument is mounted. Failure to tighten the screws could result in the tripod collapsing, causing injury.



Do not carry the tripod with the tripod shoes pointed at other persons. A person could be injured if struck by the tripod shoes.



Keep hands and feet away from the tripod shoes when fixing the tripod in the ground. A hand or foot stab wound could result.



Tighten the leg fixing screws securely before carrying the tripod. Failure to tighten the screws could lead to the tripod legs extending, causing injury.

Low-power radio technology



Warning



Do not use within the vicinity of hospitals. Malfunction of medical equipment could result.



Use the instrument at a distance of at least 22 cm from anyone with a cardiac pacemaker. Otherwise, the pacemaker may be adversely affected by the electromagnetic waves produced and cease to operate as normal.



Do not use onboard aircraft. The aircraft instrumentation may malfunction as a result.



Do not use within the vicinity of automatic doors, fire alarms and other devices with automatic controls as the electromagnetic waves produced may adversely affect operation resulting in an accident.

Precautions

Guarding the instrument against shock

When transporting the instrument, provide some protection to minimize risk of shock. Heavy shocks may affect beam accuracy.

Sudden changes of temperature

A sudden change in temperature may cause water condensation on the glass used for the laser emission part.

In such a case, let the instrument stand for a while to allow it to adjust to the temperature prior to actual use.

Caution:

Use of adjustment controls or performance procedures other than those specified herein may result in hazardous radiation exposure.

Precautions concerning low-power radio technology

SDG1 and Remote controller LRC6 use low-power radio technology for mutual communication.

Although a radio station license is not required for this instrument, bear in mind the following points when using low-power radio technology for communication.



Use of this technology must be authorized according to telecommunications regulations of the country where the instrument is being used. Contact your local dealer in advance.

Radio interference when using low-power radio technology

Low-power radio communication with the SDG1 uses the 2.4 GHz frequency band. This is the same band used by the devices described below.

- Industrial, scientific, and medical (ISM) equipment such as microwaves and pacemakers.
- Portable premises radio equipment (license required) used in factory production lines etc.
- Portable specified low-power radio equipment (license-exempt)
- Devices incorporating *Bluetooth* wireless technology
- IEEE802.11b/IEEE802.11g standard wireless LAN devices

The above devices use the same frequency band as low-power radio communications. As a result, using the SDG1 within proximity to the above devices may result in interference causing communication failure or reduction of transmission speed. In this event, change the communication channel. If the problem persists, perform operation at a distance from such devices, or turn off all unnecessary devices.

Precautions regarding transmission

● For best results

The usable range becomes shorter when obstacles block the line of sight. Wood, glass and plastic will not impede communication but the usable range becomes shorter. Moreover, wood, glass and plastic containing metal frames, plates, foil and other heat shielding elements as well as coatings containing metallic powders may adversely affect communication and concrete, reinforced concrete, and metal will render it impossible.

● Reduced range due to atmospheric conditions

The radio waves used by the SDG1 may be absorbed or scattered by rain, fog, and moisture from the human body with the limit of usable range becoming lower as a result. Similarly, usable range

may also shorten when performing communication in wooded areas. Moreover, as wireless devices lose signal strength when close to the ground, perform communication at as high a position as possible.

- The user of this product is expected to follow all operating instructions and make periodic checks of the product's performance.
- The manufacturer, or its representatives, assumes no responsibility for results of faulty or intentional usage or misuse including any direct, indirect, consequential damage, or loss of profits.
- The manufacturer, or its representatives, assumes no responsibility for consequential damage, or loss of profits due to any natural disaster, (earthquake, storms, floods etc.); fire, accident, or an act of a third party and/or usage under unusual conditions.
- The manufacturer, or its representatives, assumes no responsibility for any damage (change of data, loss of data, loss of profits, an interruption of business etc.) caused by use of the product or an unusable product.
- The manufacturer, or its representatives, assumes no responsibility for any damage, and loss of profits caused by usage different to that explained in the operator's manual.
- The manufacturer, or its representatives, assumes no responsibility for damage caused by incorrect operation, or action resulting from connecting to other products.

Laser Safety Information

SDG1 is classified as a Class 3R Laser Product according to IEC Standard Publication 60825-1 Ed. 2.0: 2007 and United States Government Code of Federal Regulation FDA CDRH 21CFR Part 1040.10 and 1040.11 (Complies with FDA performance standards for laser products except for deviations pursuant to Laser Notice No.50, dated June 24, 2007.)

Warning

- Use of controls or adjustments or performance of procedures other than those specified herein may result in hazardous radiation exposure.

Follow the safety instructions on the labels attached to the instrument as well as in this manual to ensure safe use of this laser product.

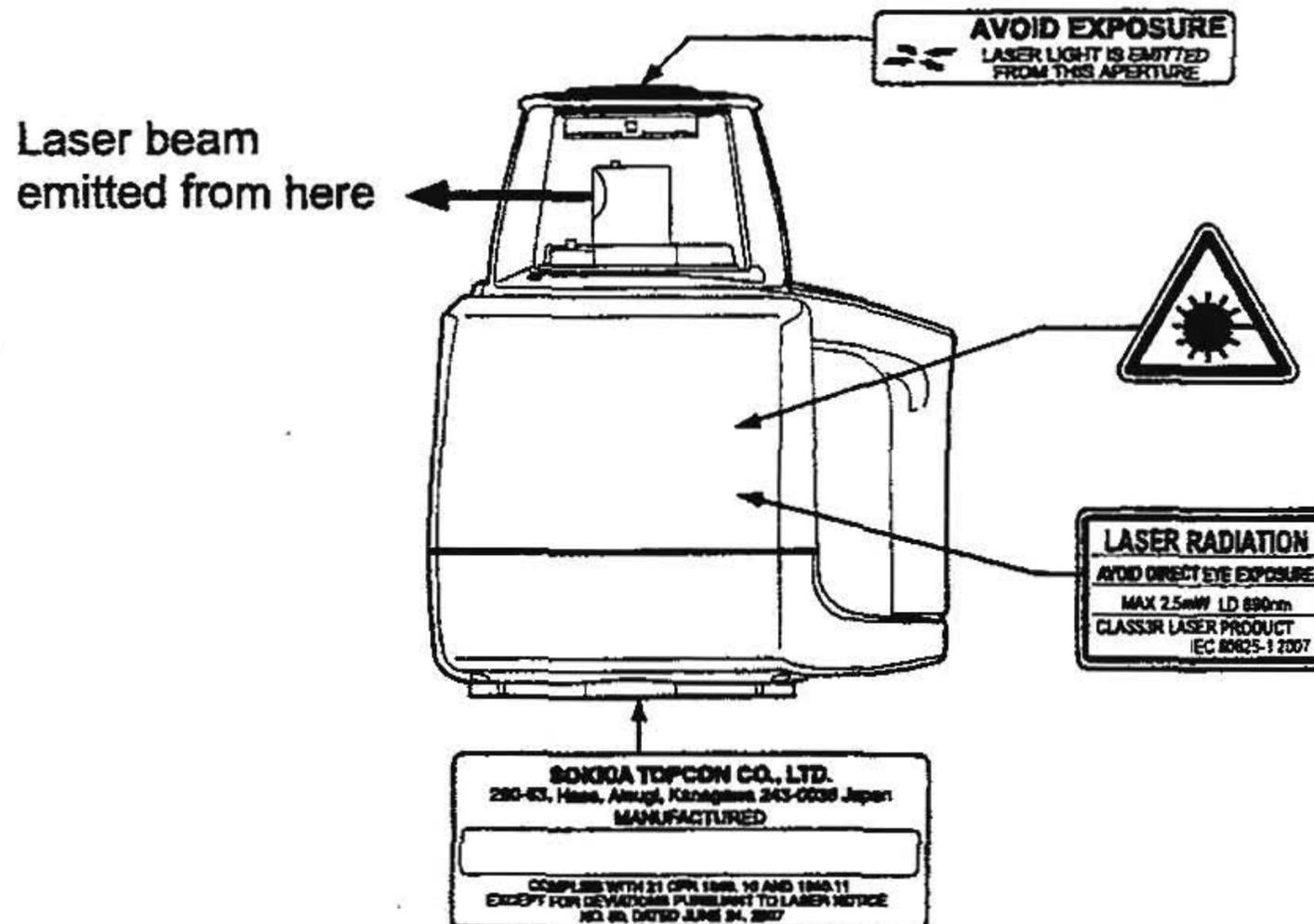

- Never intentionally point the laser beam at another person. The laser beam is injurious to the eyes and skin.
- The laser beam is emitted when the power is turned ON. Before turning the power on, make sure that persons are not located in the path of the laser beam.
- Do not look directly into the laser beam source. Doing so could cause permanent eye damage.
- Do not stare at the laser beam. Doing so could cause permanent eye damage.
- Never look at the laser beam through a telescope, binoculars or other optical instruments. Doing so could cause permanent eye damage.
- If an eye injury is caused by exposure to the laser beam, seek immediate medical attention from a licensed ophthalmologist.

Caution

- Perform checks at start of work and periodic checks and adjustments with the laser beam emitted under normal conditions.
- When the instrument is not being used, turn off the power.
- When disposing of the instrument, destroy the battery connector so that the laser beam cannot be emitted.
- Operate the instrument with due caution to avoid injuries that may be caused by the laser beam unintentionally striking a person in the eye. Avoid setting the instrument at heights at which the path of the laser beam may strike pedestrians or drivers at head height.
- Never point the laser beam at mirrors, windows or surfaces that are highly reflective. The reflected laser beam could cause serious injury.
- Only those who have been received training as per the following items shall use this product.
 - Read the Operator's manual for usage procedures for this product.
 - Hazardous protection procedures (read this chapter).

- Requisite protective gear (read this chapter).
- Accident reporting procedures (stipulate procedures beforehand for transporting the injured and contacting physicians in case there are laser induced injuries).
- Persons working within the range of the laser beam are advised to wear eye protection which corresponds to the laser wavelength of the instrument being used.
- Areas in which the lasers are used should be posted with laser warning notices.

Parts of the Instrument

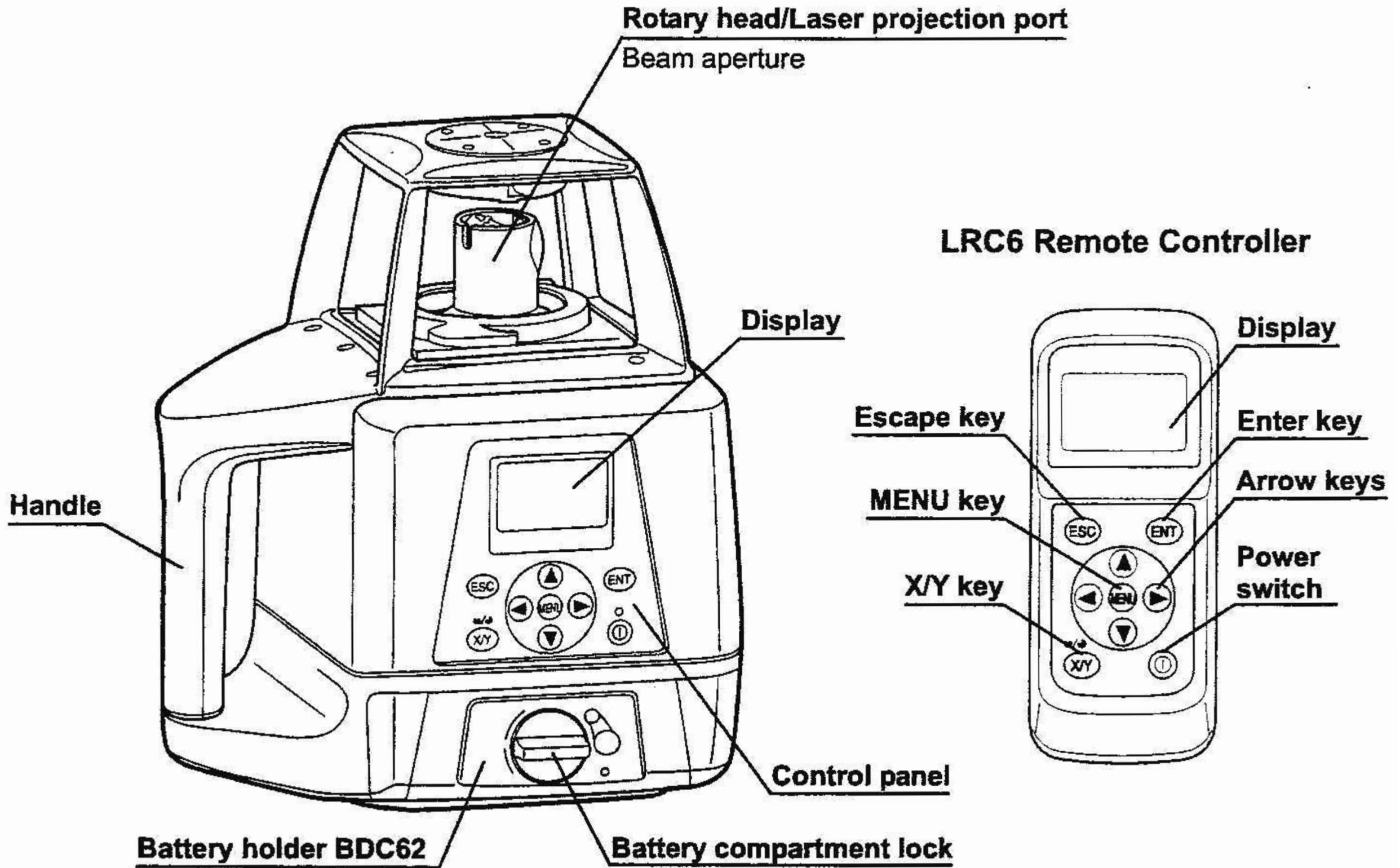

Control panel

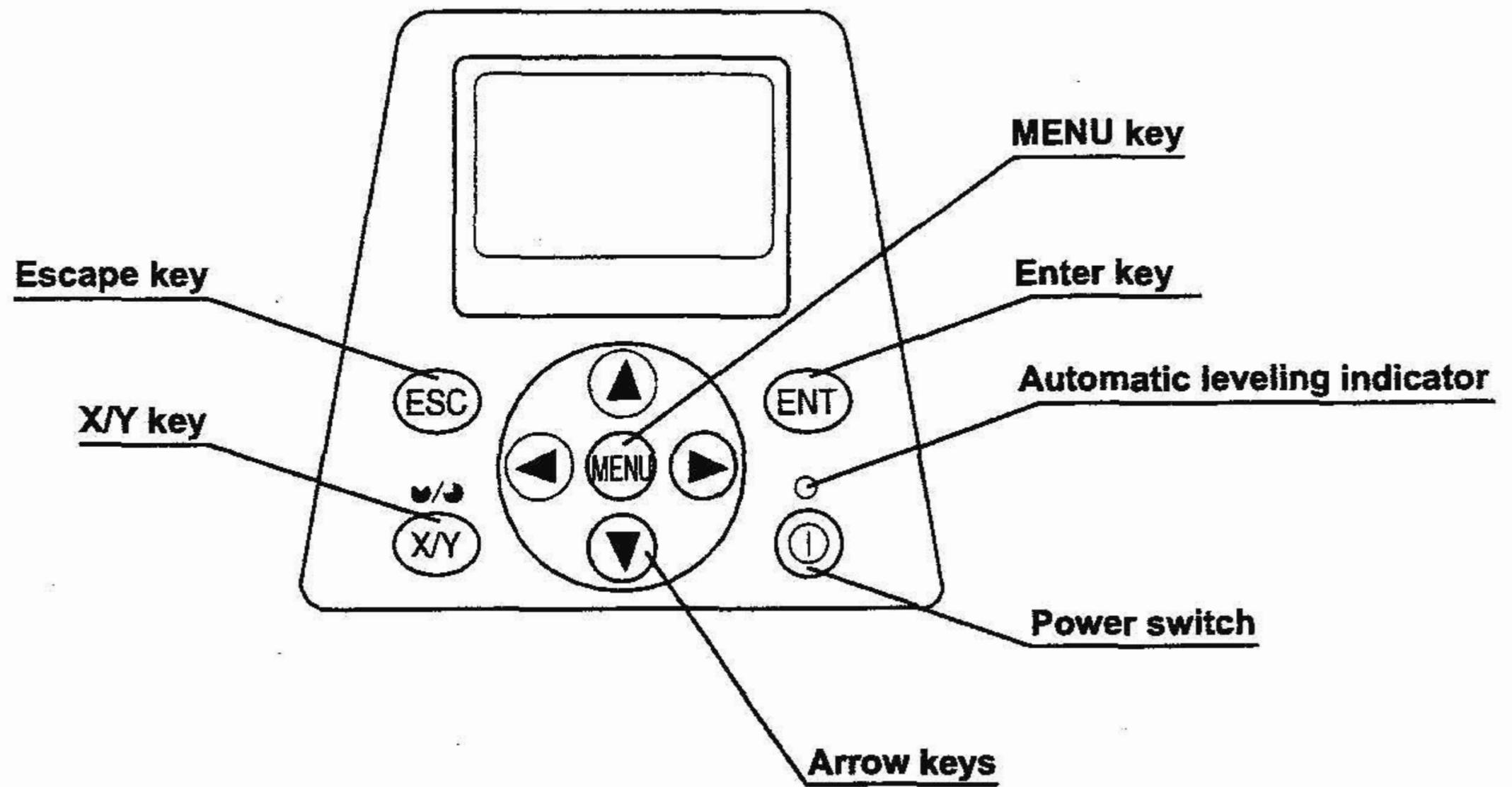

Sample Display

Normal display

X axis grade
(Blinks digit by digit during leveling)

X: -03.456%

Y axis grade
(Blinks digit by digit during leveling)

Y: +12.789%

Leveling indicator
(Blinks during leveling)

Transmission and reception display
(On remote controller only)



Transmitting



Complete



Incomplete

Rotation speed (rpm)

Channel

Remaining battery power

Dual grade laser display: SDG
Remote controller display: RC

Menu screen display



See "Menu" on page 26.

Key Functions

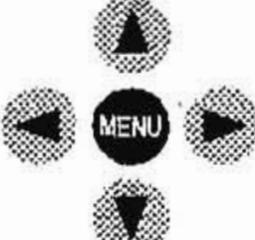
	Enter key	End Operation of Data Input and Sends data to the instrument.
	Escape key	Cancels input or escape to previous status.
	X/Y key	Sets each grade axis.
	Menu and arrow keys	Selects menu items. Inputs the grades of X Y axis. Sets the masking direction.
	Power switch	On/Off of the SDG1 and LRC6. (LRC6 has auto-cut off 60 seconds function)

SDG1 LED Display

There is an LED that signals automatic alignment of the control panel screen of the main instrument.

- Flashing :** Self-leveling or grade setting is in process.
The rotary head is not rotating.
- ON solid :** Self-leveling grade setting is complete.
The rotary head is active and emits the laser beam.



You can stop the self-levelling function. Refer to "Menu" on page 26 to stop the function.

Basic Operation

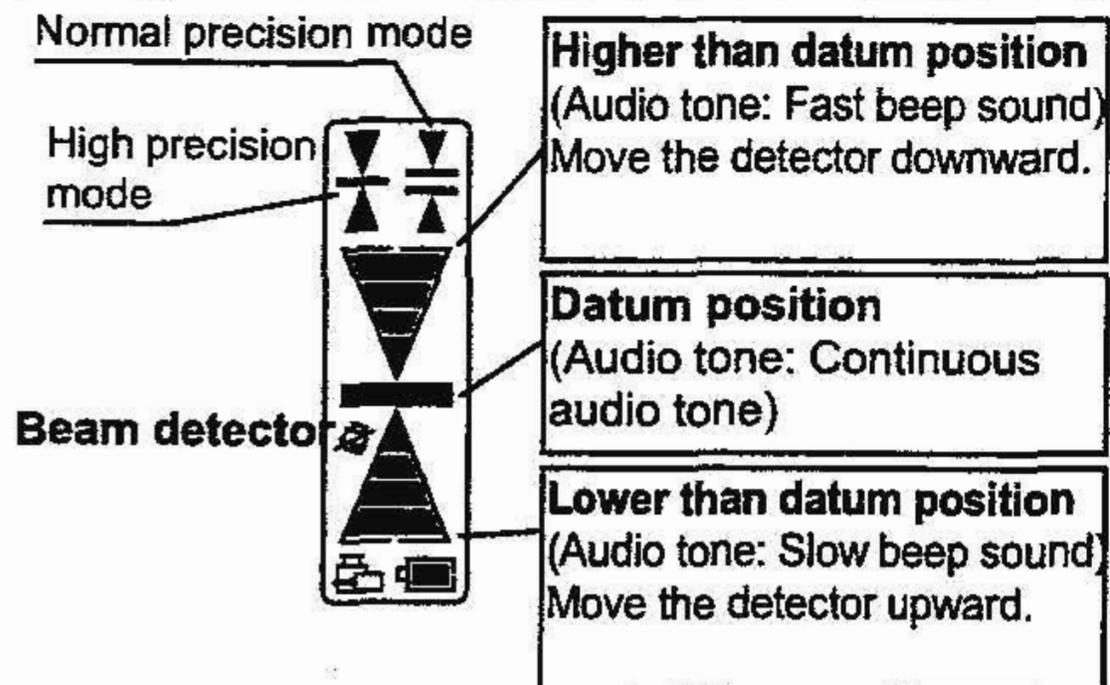
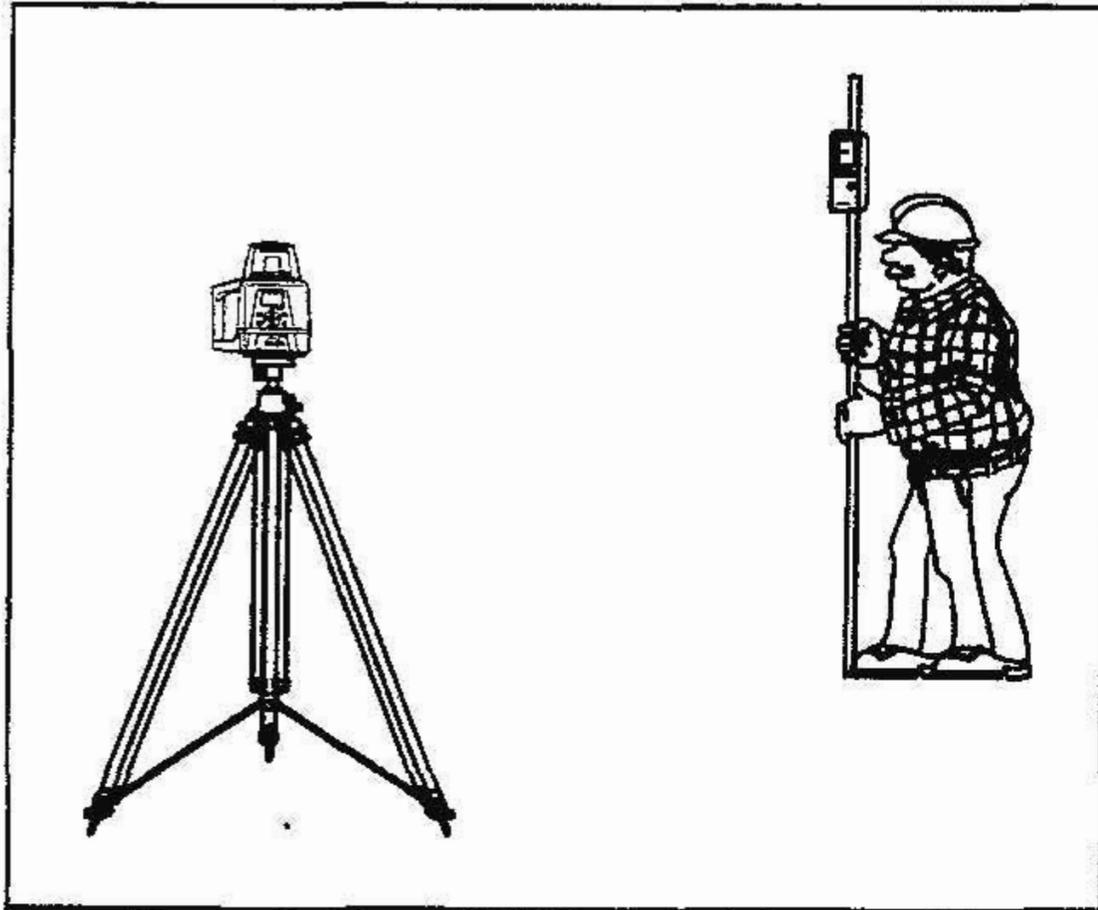

1 Set the instrument on a tripod or smooth surface and turn on the power.

When using the remote controller, turn on the power for the instrument, and then the power for the remote controller.

2 Set X and/or Y axis grades.

3 Turn on the beam detector. Check the operation surface by using the beam detector. If high-precision detection is desired, select that setting on the beam detector.

4 Check the rotating beam elevation using the beam detector.

(For more information about beam detector refer to "Standard/Optional Accessories" section.)

Preparation and Functions

Power Source

Connect the battery according to the battery type purchased.

For charging and battery replacement instructions, see the "Maintaining Power sources" section.

Setting Up Instrument

Set the instrument on a tripod or smooth surface.

The instrument must be within horizontal $\pm 5^\circ$ of true level for self-leveling to operate.

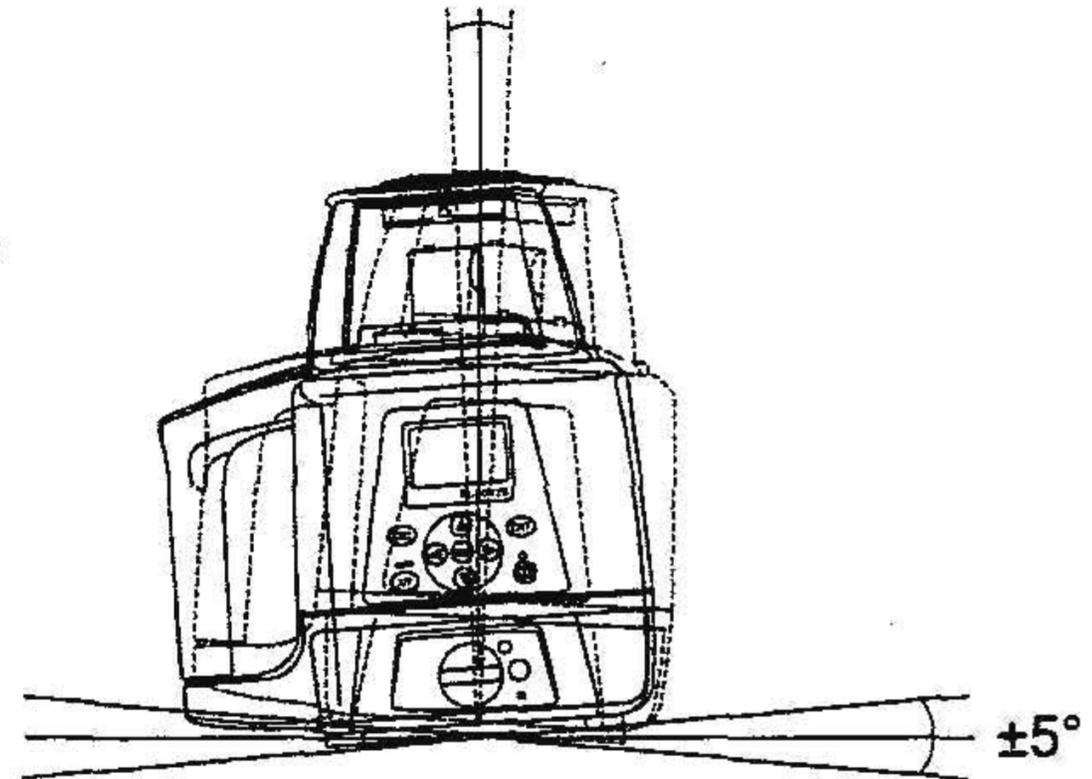

LRC6 Remote Controller

When using the remote controller, turn on the power for the instrument, and then the power for the remote controller.

Key operation

Press the [ENT] key after each key operation to lock the entry.

There will be interactive transmission between the instrument and the remote controller.

When the [ENT] key is pressed, entered information is transmitted from the remote controller to the instrument. When information is received by the instrument, it sends out signal of its confirmation to the remote controller.

Please check the display to make sure that the entry is correctly performed. (It will not be displayed on the display screen of the instrument.)

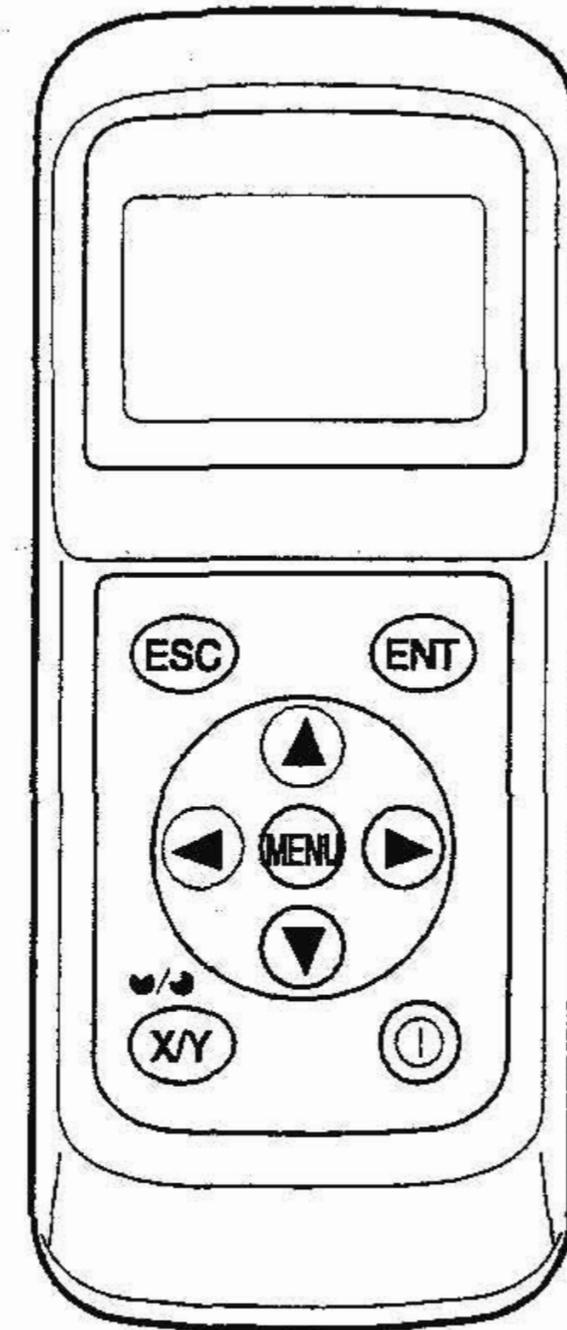

Transmission and reception display

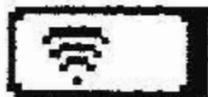

Transmitting



Complete



Incomplete



- 1) The working range of the remote controller is up to a distance of about 300 m from the instrument.
- 2) It is necessary to install batteries when using the remote controller. Install the batteries by referring to "Maintaining Power Sources" on page 35.
- 3) The power of the remote controller shuts off automatically after about 60 seconds when key or leveling operations have been completed (Auto Power Cut Off Function). When using it in the temperature -10°C or lower, warm up function will activate and the power for the remote controller shuts off automatically in about 5 minutes after warm up is completed.
Press the power switch once to restore power to the remote controller after the auto power cut off function has been activated.

Common use of LRC6 remote controller

LRC6 remote controller can control multiple SDG1 units. When you are using multiple SDG1 units at your job site, you can use your LRC6 for the other SDG1 units. Change the channel to receive the internal data of each SDG1 to the LRC6 by operating the LRC6.

This function enables operating of each SDG1, by transmitting and displaying the data of each unit to the remote controller before operation.

See page 30 for the operation "3) Setting channel".

Power Switch

When the power switch on the instrument is turned on, automatic alignment and automatic grade setting will activate.

When using the LRC6 for wireless remote control, also turn the instrument ON or OFF by pressing the power switch on the LRC6.

When transmission had not been correctly performed, "NG" will appear at the lower left of the screen. In such case, please turn the power on once again.

Always turn off the power for the LRC6 before turning off the power for the instrument after the operation. If you forget to turn off the instrument before the LRC6, the instrument will go into standby mode and the power will not turn off completely.

When the power is not turned off for the instrument.

Standby mode

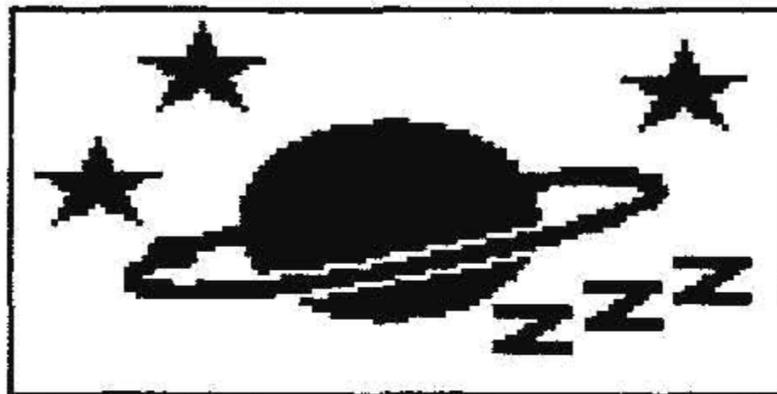

Instrument will go into standby mode when turning off the power by remote controller.
The power of instrument will turn off completely after 3 hours in standby mode.

The channel on the SDG1 is not same as one on the LRC6 (Remote mode).

- 1** If the channel on the main unit is different from that on the remote controller when the power switch is turned ON, the channel on the main unit will be automatically searched for. [SEARCHING...] will be displayed.
- 2** When the search is finished, the available channel and serial number of the instrument will be displayed. If more than one channel is displayed, use the arrow key (up/down) to position the cursor on the channel you want to select. Press the [ENT] key to select that channel.

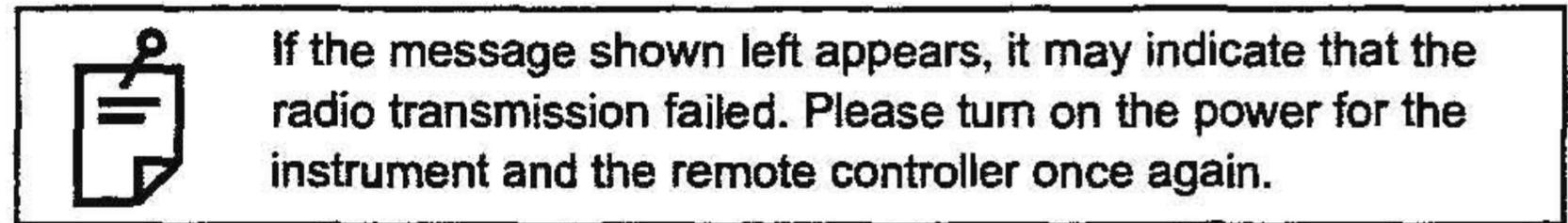
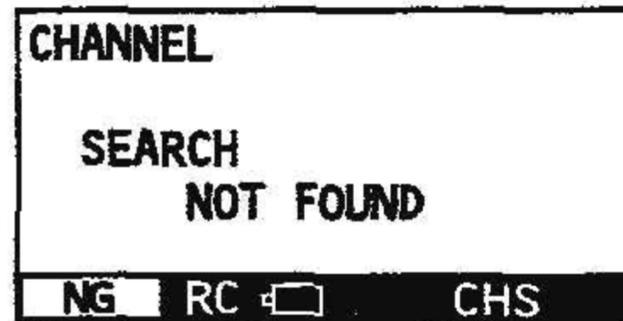

Battery Status Display

Remaining battery power level is displayed at the lower bar in the display area.



Remaining battery display

Dual grade laser display: SDG
Remote controller display: RC



Battery is sufficient.



Battery is sufficient.



Battery is sufficient.



The power is low, but laser is still usable. (Indication continues until batteries are depleted.)

SDG1 BATTERY Low
or
LRC6 BATTERY Low
(Displayed on the LRC6 only)

Depleted batteries of SDG1 or LRC6. Recharge the battery or replace the dry batteries with new ones.



If an AC adapter is connected to the main instrument when the main instrument is displaying "SDG1 BATTERY LOW", the remaining battery power level display will not change.

Once the power is turned off, the remaining battery power display will reset.

For handling batteries, see the "Maintaining Power Sources" on page 35.

Setting Grades

Grade can be set in both axes, X and Y, as shown below.

Grades can be set in the range indicated below.

X: -10% to +10%

Y: -5% to +25%

Grade axes and axis symbols are as shown in the diagram below.

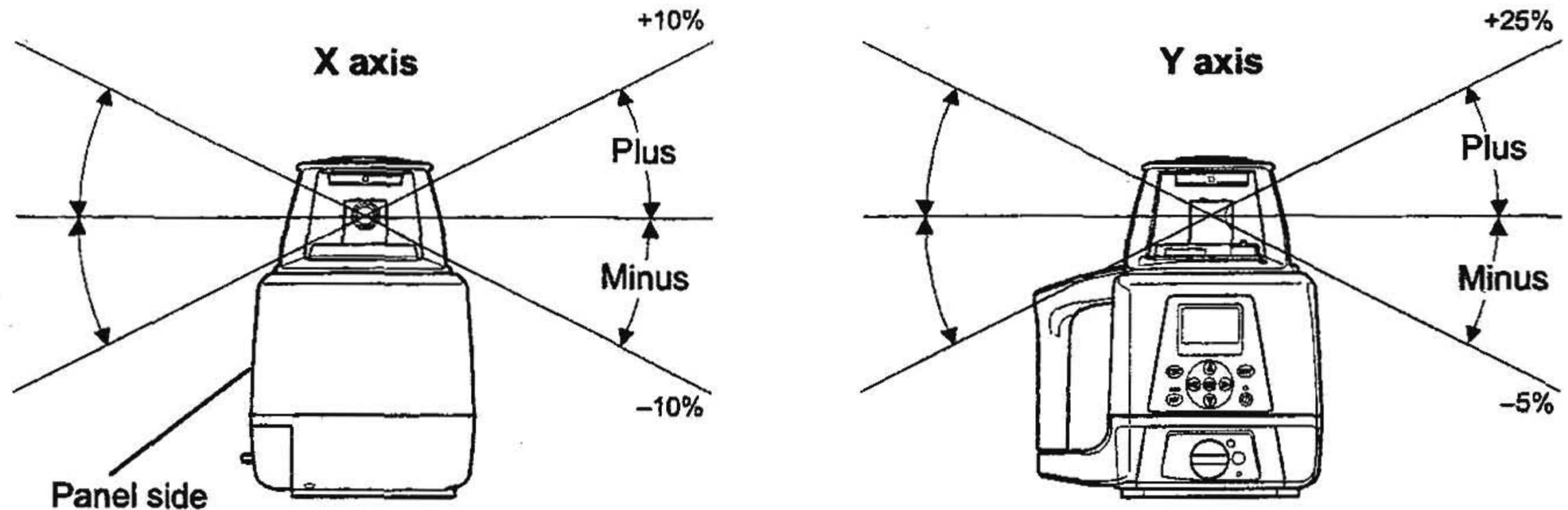

Aligning Direction of Grade

When using the laser with a percent of grade entered, the laser must be properly aligned so the slope of the laser beam is parallel to the desired direction of grade.

The sighting collimator on top of the instrument is calibrated to the grade axis of the laser beam. Follow the steps below to align the laser to the desired direction of grade:

- 1** Establish a target line parallel to desired direction of grade.
- 2** Set up the laser over this line (drop a plumb bob from the tripod mounting screw).
- 3** Rough align the instrument to the direction of grade. Make sure it is properly oriented for the grade to be entered, positive or negative. (See page 23)
- 4** Place a rod or other target down range on the target line.
- 5** While sighting through the collimator, adjust the instrument until the sight is aligned with the target. (See the figures on the right.)

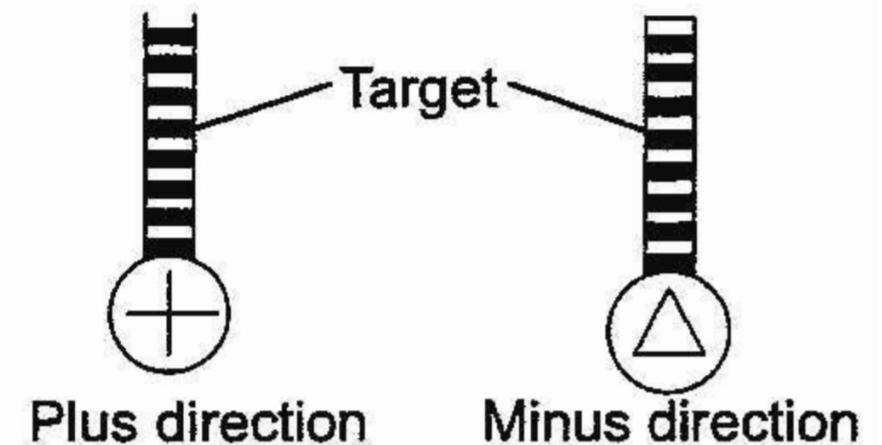
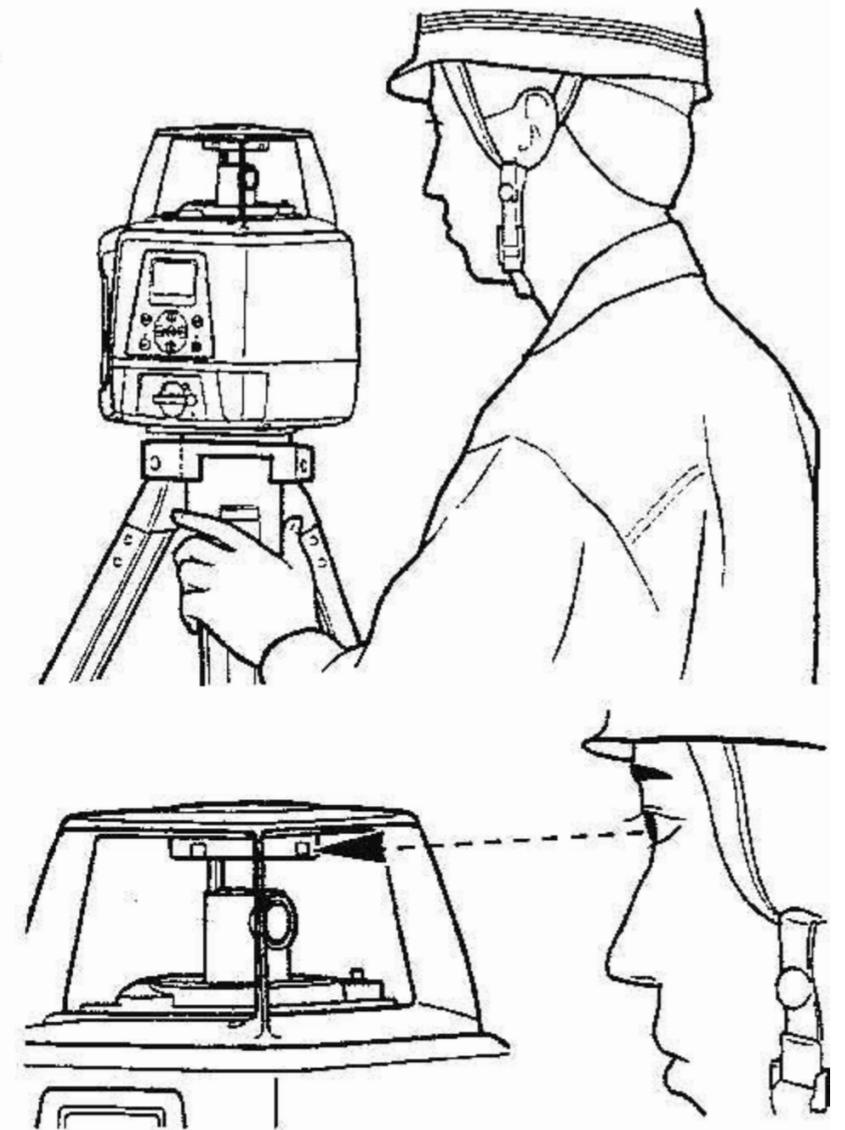
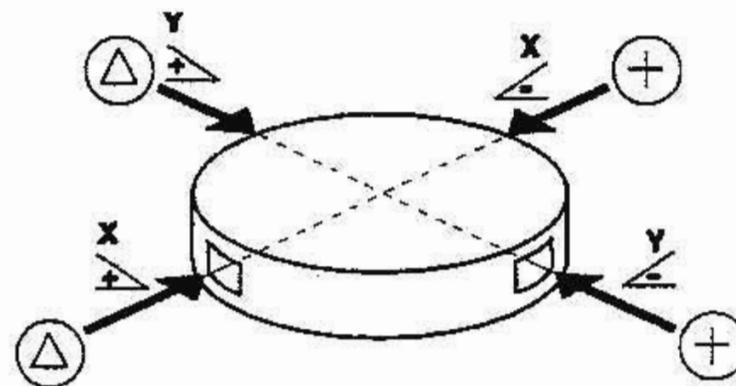

Single axis

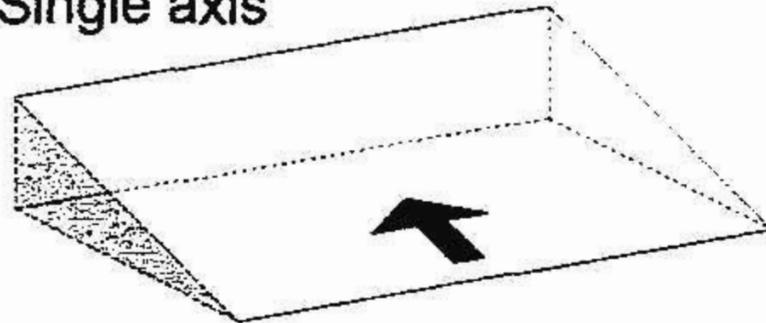

Grade range:
X: -10% to +10%
or
Y: -5% to +25%

Dual axes

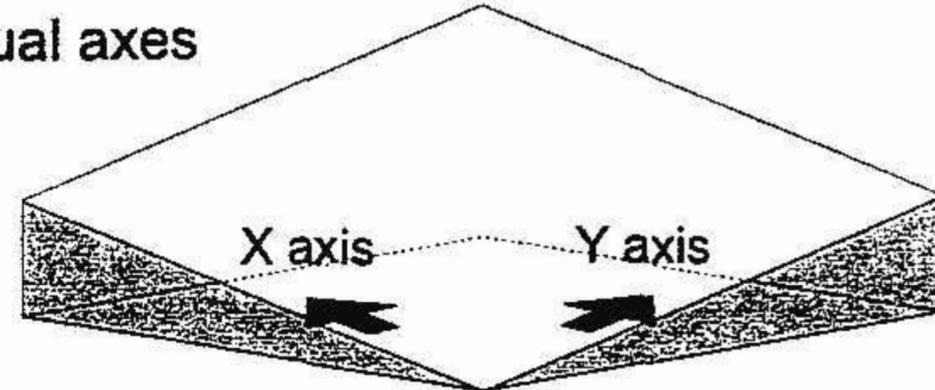

Grade range:
X: -10% to +10%
Y: -5% to +25%

How to Enter Grade

- 1** Press the X/Y key to begin grade input.
The axis symbol will flash and it will go into grade entry status.
(The X and Y axis displays will switch with each push.)
- 2** Select positive or negative grade by pressing arrow keys (Up or Down).
- 3** Move the cursor by pressing the arrow keys (Right or Left).
- 4** Increase or decrease the number by pressing the arrow keys (Up or Down).
- 5** Press the [ENT] key to finish input.

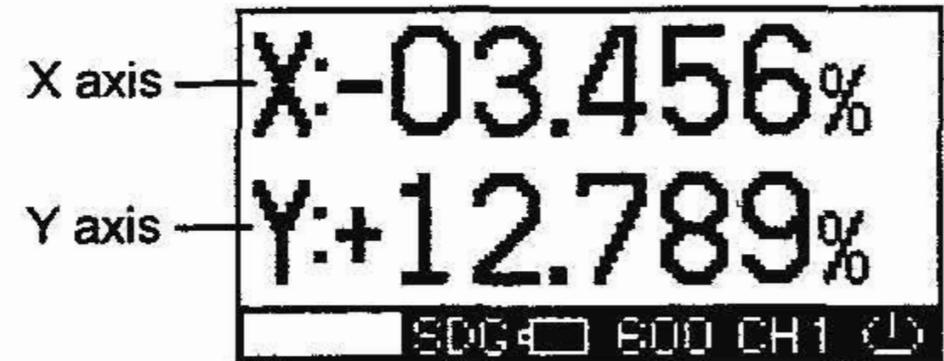

When setting up using the remote controller

Confirm the [OK].

If the [NG] mark is displayed, press the [ENT] key.



When holding down the [X] or [Y] key while the X or Y symbol is flashing, the flashing axis will reset to 00.000%.

Menu

How to Set the Menu

As indicated by arrows in the figure, there are 6 setting categories in the menu and selection and changes of the settings are performed using the arrow keys and [ENT] key.

- 1** Press the menu key to display the menu screen. As you can see, the mask setting is framed with the cursor.
- 2** Move the cursor to the item you would like to set up using the arrow keys and press the [ENT] key. The selected item will start flashing.
- 3** Select the setting details using the arrow keys.
- 4** Press the [ENT] key to lock the setting.
When setting up using the remote controller, make sure that "OK" is displayed on the transmission and reception display. If "NG" is displayed, press the [ENT] key once again.
- 5** In the same manner, select and change the next setting.

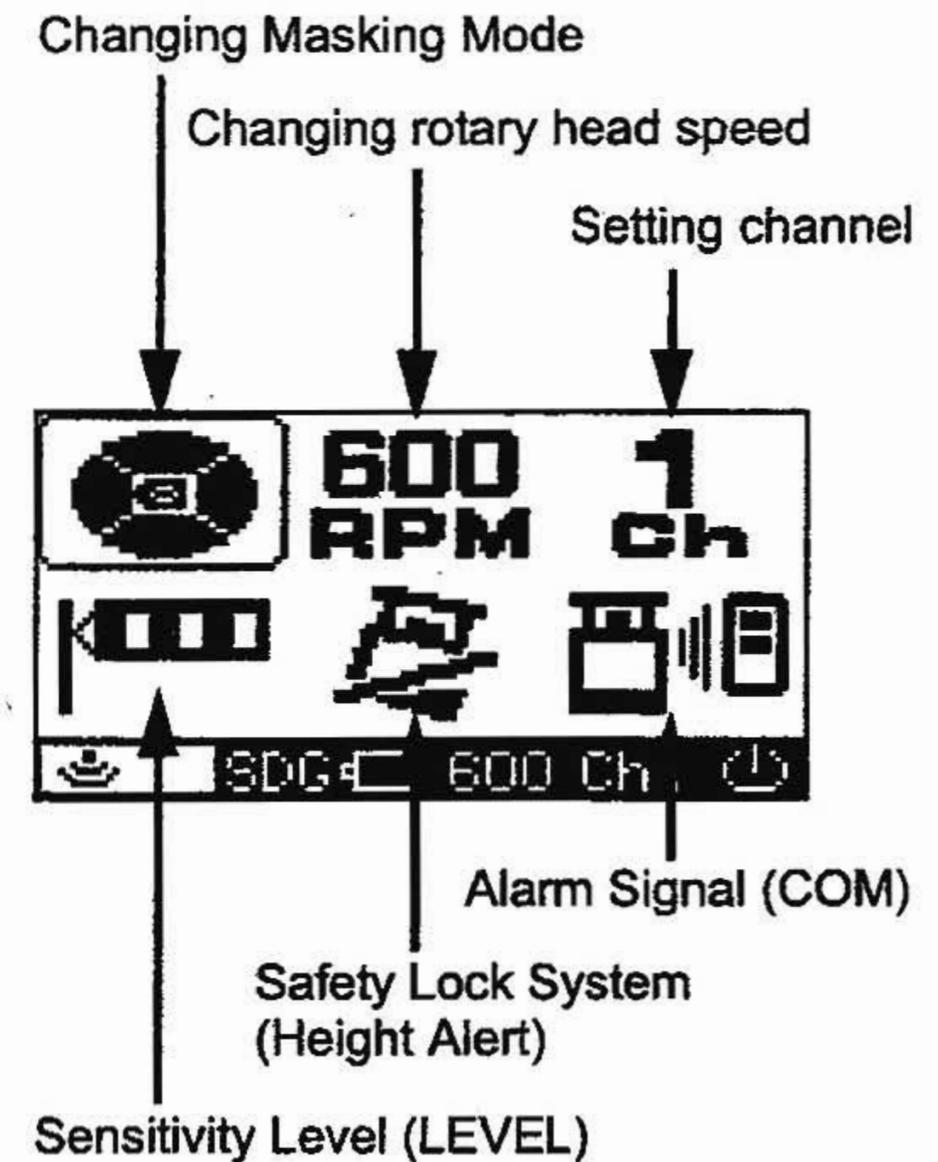

The menu allows setting of the following functions.

- | | |
|--------------------------------------|-------------------------------|
| 1) Changing Masking Mode | 2) Changing rotary head speed |
| 3) Setting channel | 4) Sensitivity Level (LEVEL) |
| 5) Safety Lock System (Height Alert) | 6) Alarm Signal (COM) |

1) Changing Masking Mode

Sets up masking (laser beam shut off) and change shut off directions.

Masking (Laser beam shutter) setting

Depending on the status of the location where the instruments are used, laser beam emission in unnecessary directions can be shut off.

- 1 Press menu key to display the menu screen.
The mask setting will be displayed on the right in the upper side of the screen.
- 2 Use the arrow keys to position on the Mask display and press the [ENT] key.
- 3 Select the direction you desire to mask using the arrow keys.
Each press repeats mask activating/releasing.
- 4 When desired masking is displayed, press the [ENT] key to finish.
Confirm the [OK] mark on the display



The state when masking is not activated
(Laser beams are emitted to all directions.)

When setting up using the remote controller

After completing 1 through 4 of the above setting procedures, check that the transmission and reception display is showing "OK".

If the [NG] mark is displayed, press [ENT] again. ("OK" and "NG" will be displayed only on the remote controller screen.)

Switching Masking Mode

Mode 1

As seen from above

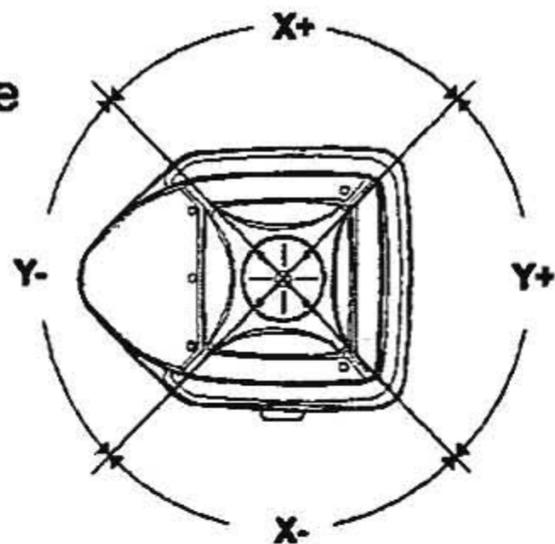

Displays the masking direction

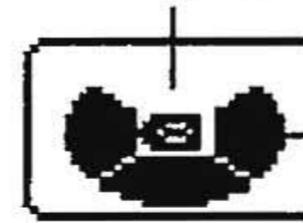

Displays the direction that laser beam is emitted.

The status in which the X+ direction is masked.
(Laser beam is shut off in the X+ direction.)

Mode 2

As seen from above

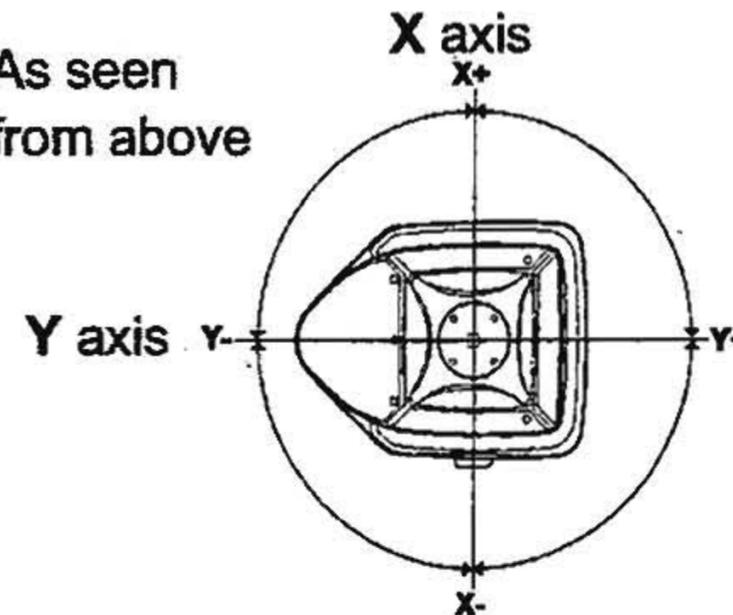

You can select either Mode 1 or Mode 2 for the masking mode (split-masking direction). The relationship between the arrow keys and masking directions are shown in the above figure.

Masking Mode Setting

- 1 Follow steps 1-2 for the masking setting.
- 2 Each press of the [X] or [Y] key toggles Mask Mode 1 and Mask Mode 2.
- 3 Press the [ENT] key to lock the entry. When setting up with the remote controller, make sure that "OK" is displayed on the transmission and reception display. If "NG" is displayed, press the [ENT] key once again.

Sample display



Mode 1



Mode 2

2) How to change the rotary head speed (300, 600, 900 R.P.M.)

The rotary head speed can be set to 300, 600 or 900 R.P.M.

Press the menu key to display the menu screen. Use the arrow keys to select the rotary head speed and press the [ENT] key. When the head speed starts flashing, select the desired speed using the arrow keys and press the [ENT] key.



Rotation speed

3) Setting channel

[Setting from the control panel of the instrument]

Only channel on the instrument can be changed.

[Setting from the remote controller]

Only channel on the remote controller can be changed.

[Changing a channel setting by searching] *LRC6 only

- 1 Set channel display to "SEARCH" as later described in "How to set the menu", press the [ENT] key to lock entry.
- 2 Search for the channels available on active or standby SDG1.
When the search is completed, searched channels will be displayed.
- 3 Use the arrow keys (up and down) to position the cursor on the channel you want to select and then press the [ENT] key.



When using more than one units, do not use the same channel at the same time.



You may set the channel from 1 to 9.

[Setting Channel]



[Channel setting by searching]

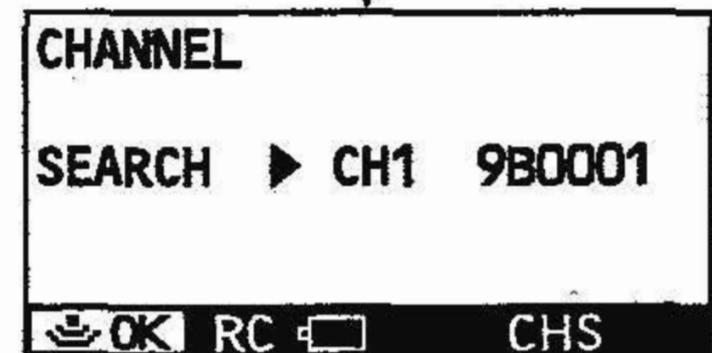
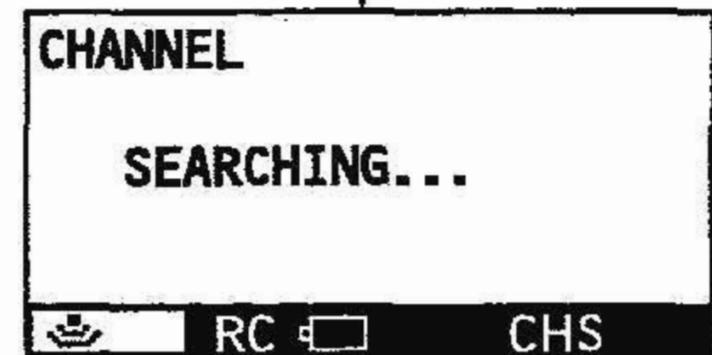
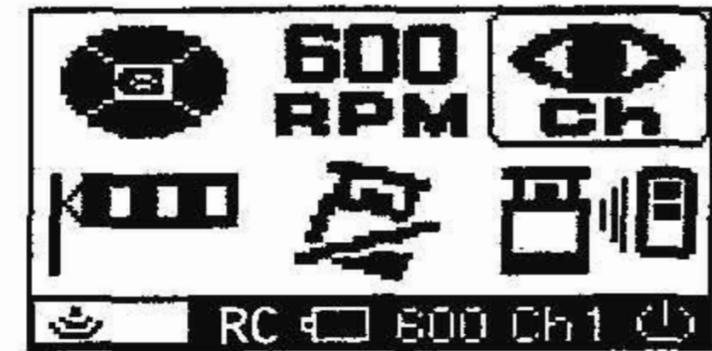

4) Sensitivity Level (LEVEL)

The sensitivity level allows the user to select the vibration level that is permitted during automatic alignment or grade setting. Set a sensitivity level to suit the location where the instrument is used such as places that undergo many vibrations, and also in consideration of the operational precision.

Two sensitivity levels can be set: large and small vibrations.

Manual setting will stop the automatic alignment function.

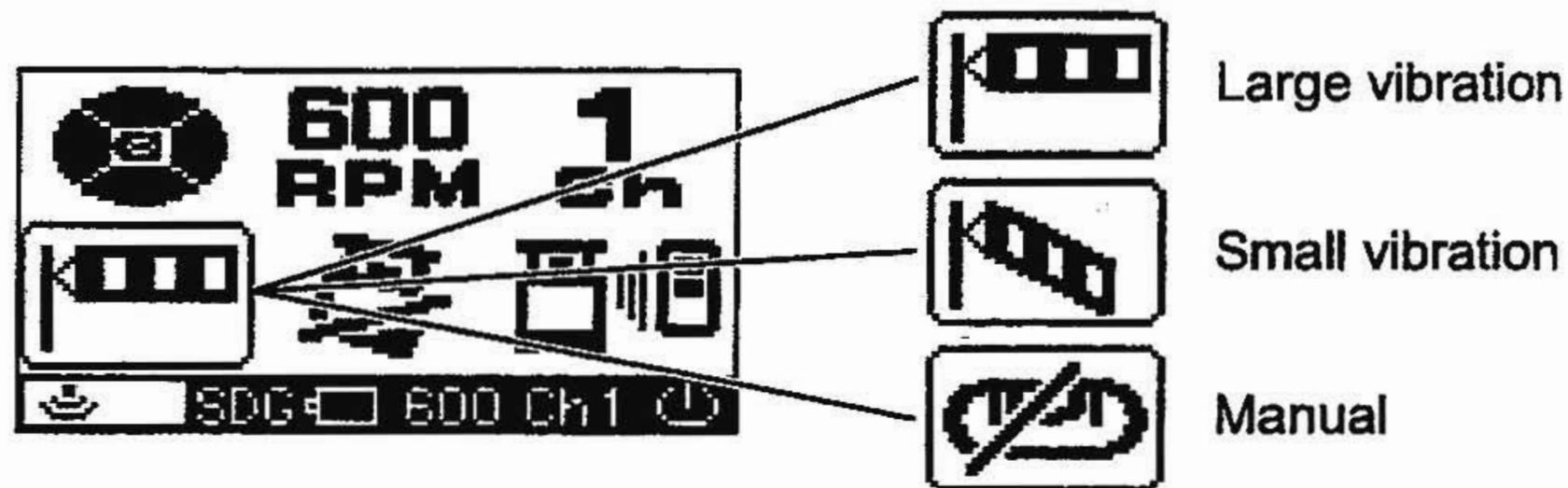

Do not use the manual setting for sensitivity level except in special circumstances. If the manual setting is selected, the automatic alignment function will not operate, so the grading setting precision will not be assured at all. The manual setting will also deactivate the settings for X- and Y-grades.

5) Safety Lock System (Height Alert)

In case the [ALERT] setting is ON. Safety Lock System will active. (This will be active around 10 minutes after turning on the power.)

Should the installed status of the instrument suddenly change when automatic alignment is functioning and laser beam is being emitted, through, for example, unnecessary contact by the user, the automatic alignment function will automatically stop to protect operational precision.

In such a case, the rotary head will act as below:

When [6) Warning transmission] is activated: it will rotate slowly

When [6) Warning transmission] is not activated: the rotation will stop

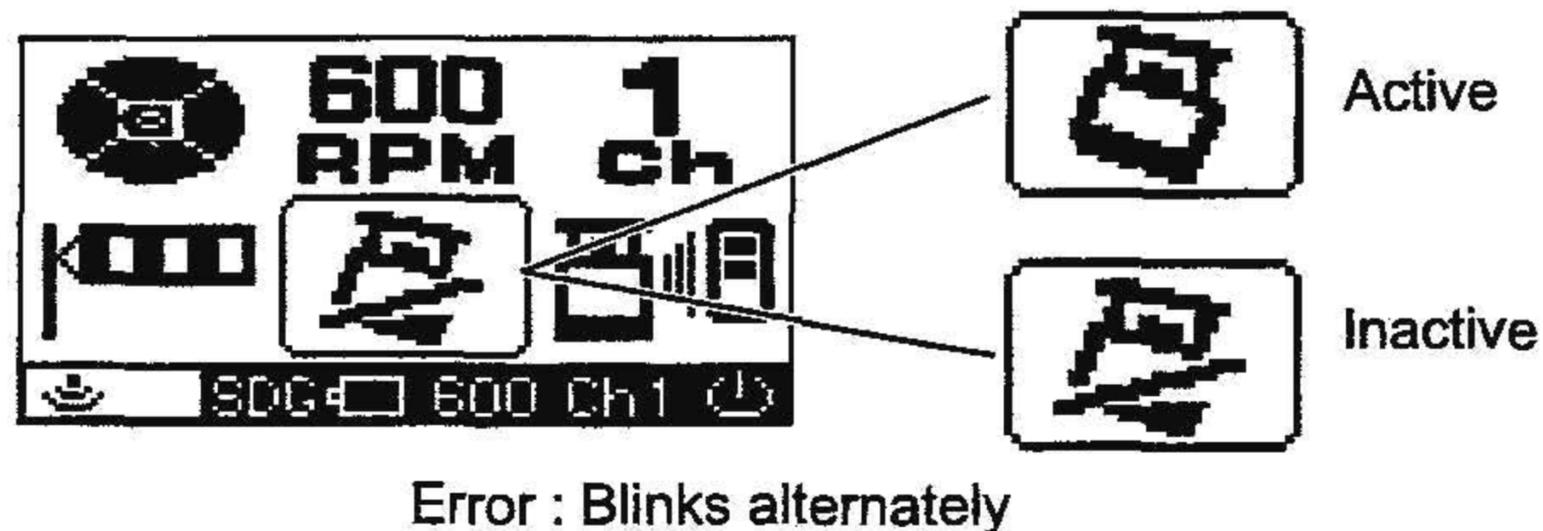

How to reactivate

Turning off the power for the instrument, and then turning it back on will activate the automatic alignment function.

6) Alarm Signal (COM)

When used with the beam detector, the SDG1 can communicate alarm signals directly to the detector. This helps enable the user to be completely aware of potential problems before they can become serious.

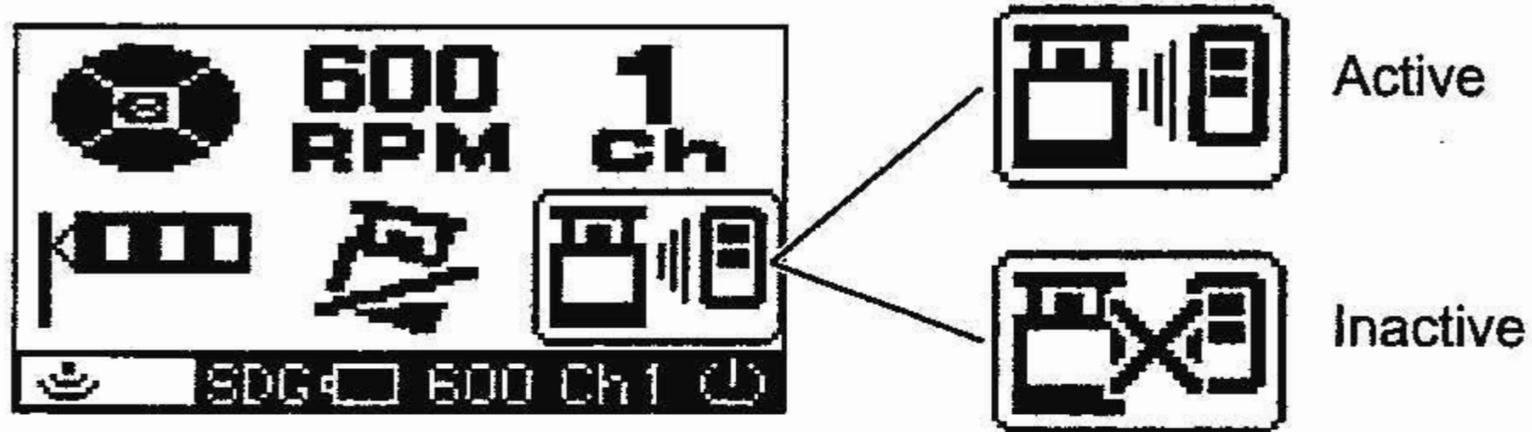

Concerning initial operation in a low temperature

When the instrument and remote controller are used in a temperature below -10°C , a warm up operation of approximately 4 minutes is necessary for the LCD after the power is turned on. During the warm up operation, no operation is possible except turning the power switch on/off. The instrument will perform automatic alignment; however, when the automatic alignment has been completed, the instrument will go into a standby state until the warm up operation is completed (the rotary head is in a resting state). After the warm up operation is completed, the instrument and remote controller will function normally.

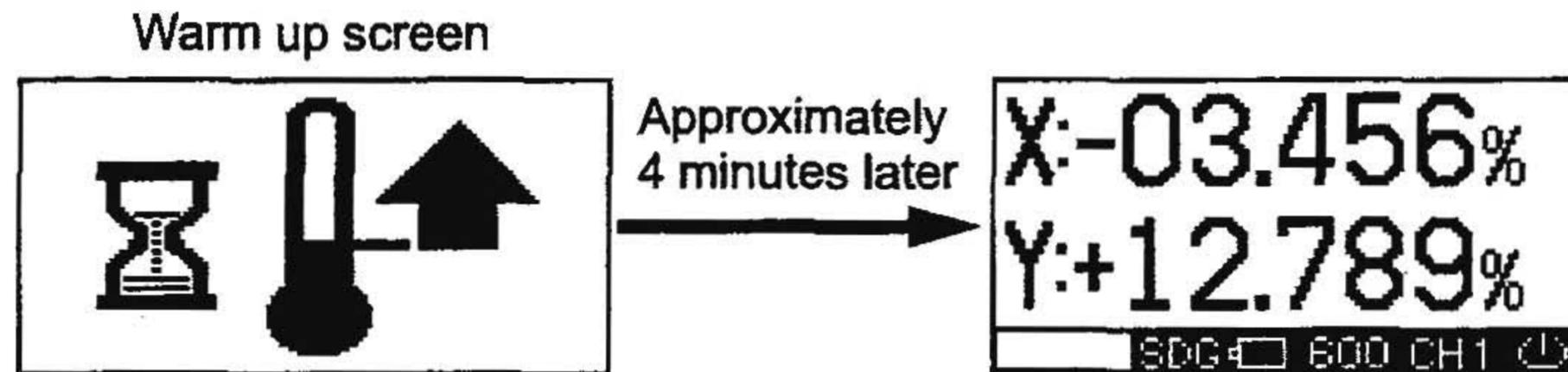

During the warm up operation, the instrument will continue the operation even if the power of the remote controller is turned off. (The instrument will not go into a standby state.)

When the power is turned off after the warm up operation is completed, the instrument will begin warm up operation again when the power is back on.

Maintaining Power Sources

How to Change Batteries on the Instrument

Rechargeable battery

Installing

- 1 Insert Battery BDC63 into the battery holder BDC62.
- 2 Insert the BDC63 into the instrument and turn the battery cover knob to "LOCK".

Charging

- 1 Plug the AC adapter AD-11 into the battery holder.
- 2 Plug the adapter power cable into the appropriate AC outlet.
- 3 When charging is complete (after approximately seven hours), unplug the adapter from the connector on the battery holder.
- 4 Unplug the adapter power cable from the AC receptacle.

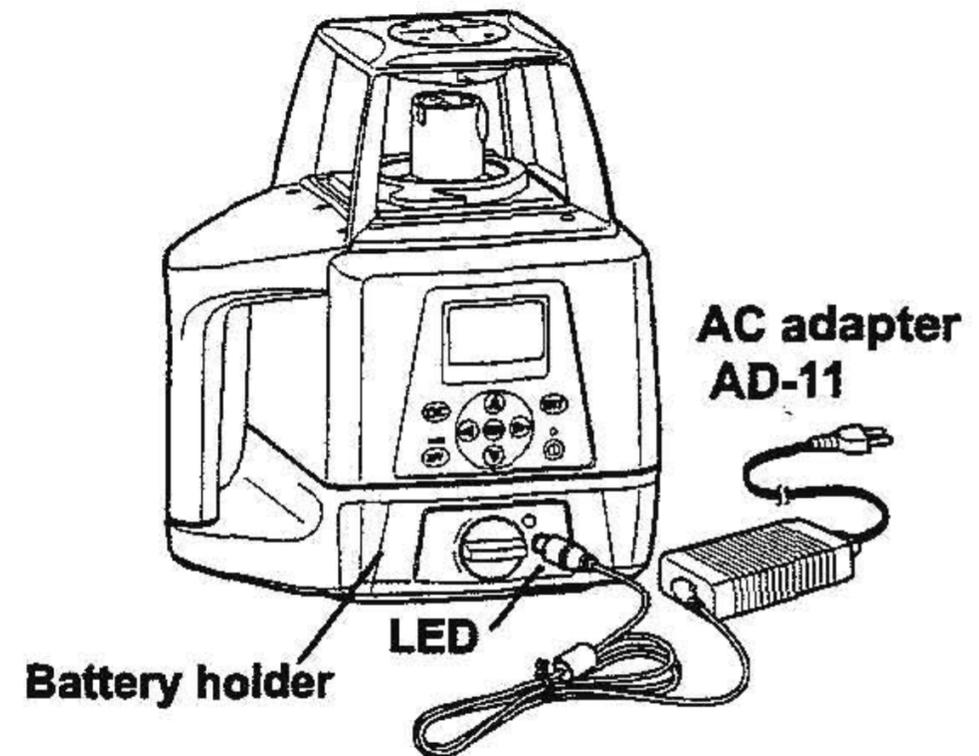

The LED of the battery holder will indicate charging status:

- Red ON : Charging.
- Green ON : Charging completed.
- Green flashing : Battery BDC63 is not installed correctly.
- Red flashing : Battery BDC63 protection feature is working automatically.
SDG1 can be used in this state.

The instrument has a protection feature which works when nickel hydride batteries are overcharged or when the batteries are under a high or low temperature (+70°C or higher, or 0°C or lower) state. In such a case, charging will stop automatically to protect nickel hydride batteries.



Recharging should be performed in a room temperature ranging from +10°C to +40°C.
Always use the AC adapter provided with the product.



- 1) The BDC63 can be charged while using the laser.
- 2) The BDC63 can be charged when the battery holder is removed from the instrument.
This allows the option of alternately using two battery packs to always maintain a fully charged pack.

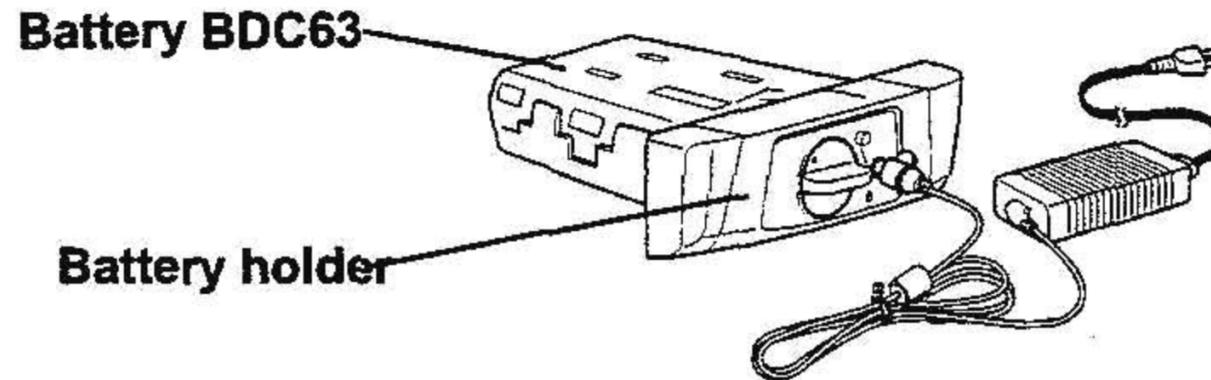

- 1) For longer battery life, conform to the suggested charging time to the extent possible.
- 2) The battery source will discharge when stored and should be checked before using with instrument.
- 3) Be sure to charge stored battery source every 3 or 6 months and store in a place at 30 °C or below.
If you allow the battery to become completely discharged, it will have an effect on future charging.

Dry batteries

When using dry batteries

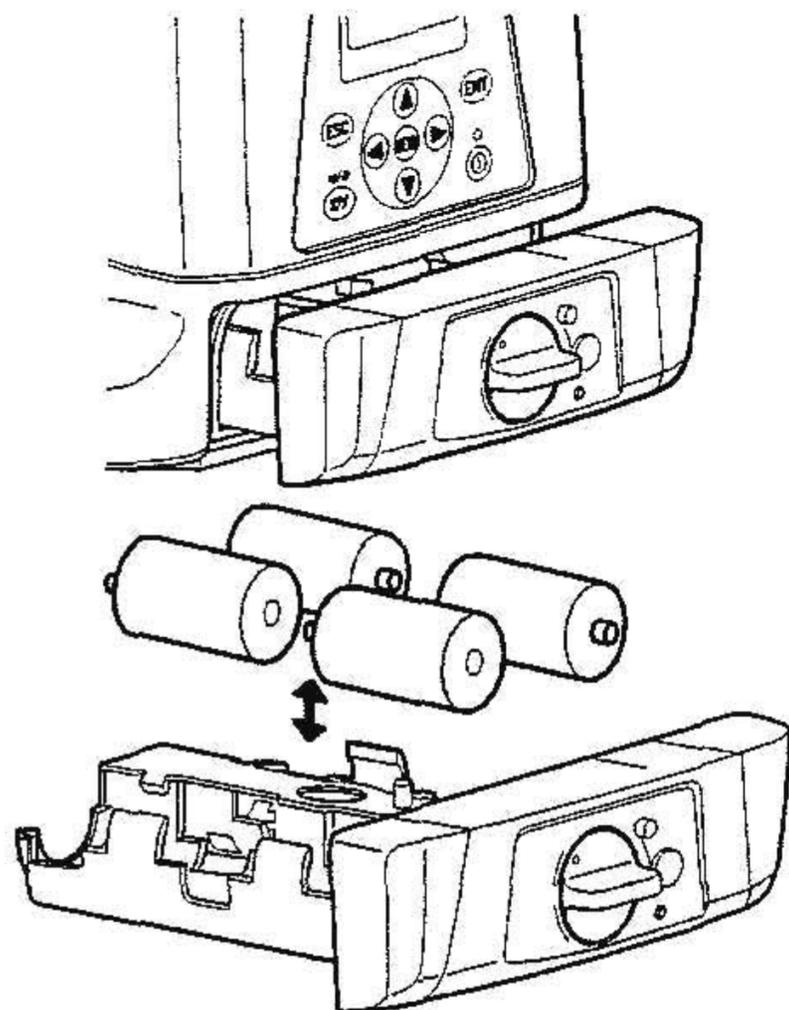

- 1** Remove the battery cover by turning the battery cover knob to "OPEN".
- 2** Unfasten the BDC63 from the battery cover and remove. In its place insert new dry batteries (four D batteries) matching [+] and [-] as shown in the figure.
- 3** Slot the battery cover back into the SDG1 and turn the knob to "LOCK".



When replacing old dry batteries, replace all 4 batteries with new ones.
Do not mix old batteries and new ones.

How to Replace the LRC6 Batteries

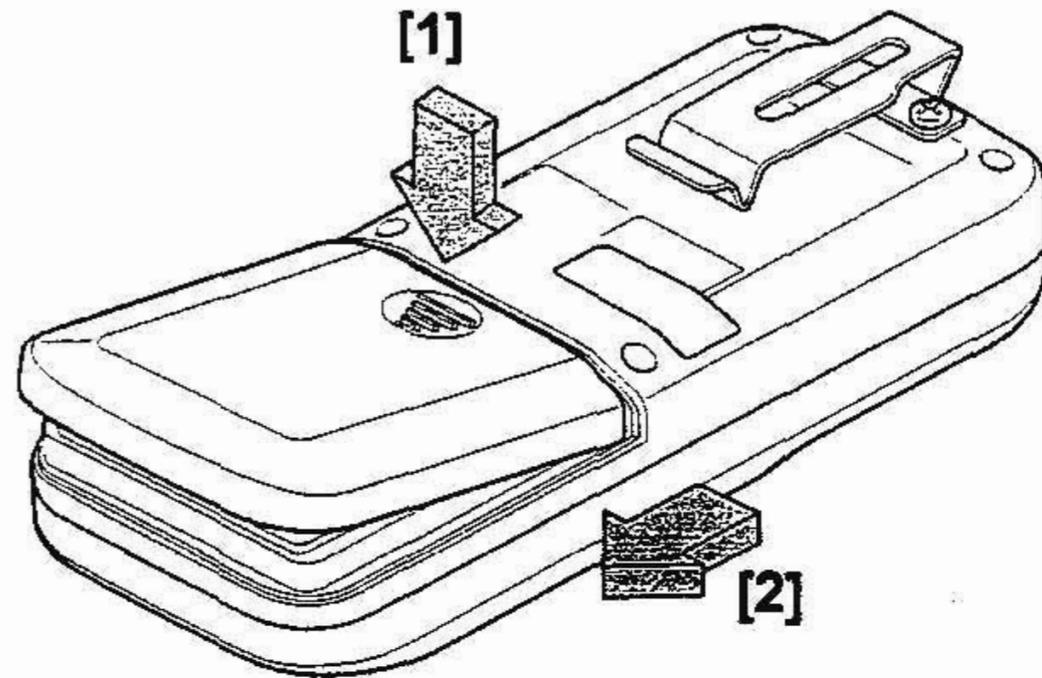

- 1** Keep pushing the battery cover in [1] direction, and then try to slide the cover in [2] direction. The cover does not move but it will be open.
- 2** Remove the old batteries and replace with new batteries (three AA batteries), matching [+] and [-] as shown in the figure.
- 3** Replace the battery cover.



Replace all 3 batteries with new ones.
Do not mix old batteries and new ones.

Checks and Adjustment

Horizontal Calibration

(1) Checking Calibration

- 1 Steadily set up a tripod approximately 50m from a staff or wall and adjust so that the head of the tripod is horizontal.
Mount the instrument on the tripod in the direction shown in the right figure (Y-axis facing the wall).
- 2 While pressing the [X] or [Y] key, turn on the power switch.
- 3 The flashing axis is the selected one.
Select the axis to check using the arrow keys (right and left) and press the [ENT] key to lock.

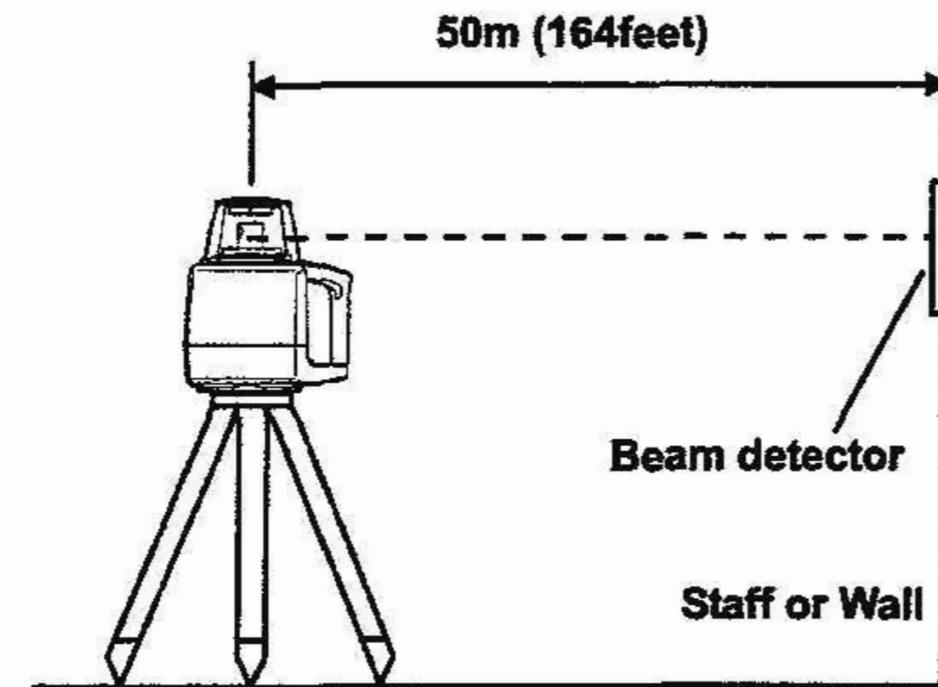
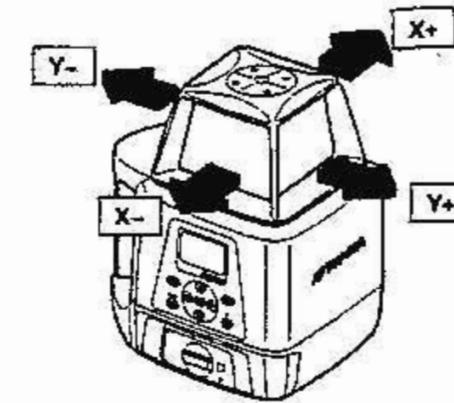

Turn on the power while pressing the [X] or [Y] key.



Select the axis using the arrow keys (right and left) and press the [ENT] key.



(Example: Y axis)

- 4 Select Y axis by pressing the right arrow key.
Press the [ENT] key to lock.
- 5 "POSITION 1" display will flash and the instrument will begin automatic alignment. After the automatic alignment is completed, the "POSITION 1" light will turn on, then, the rotary head rotates and emits laser beam. (Y-).
- 6 Turn on the power for the beam detector, and press the precision setting shifting switch to select the high detection mode.
- 7 Check the position of the laser beam (Y-) on the wall.
Move the detector up or down until the LCD indicator identifies the center of the laser beam.
- 8 After fixing the beam, press the [ENT] key.
The display will change to flashing "POSITION 2".

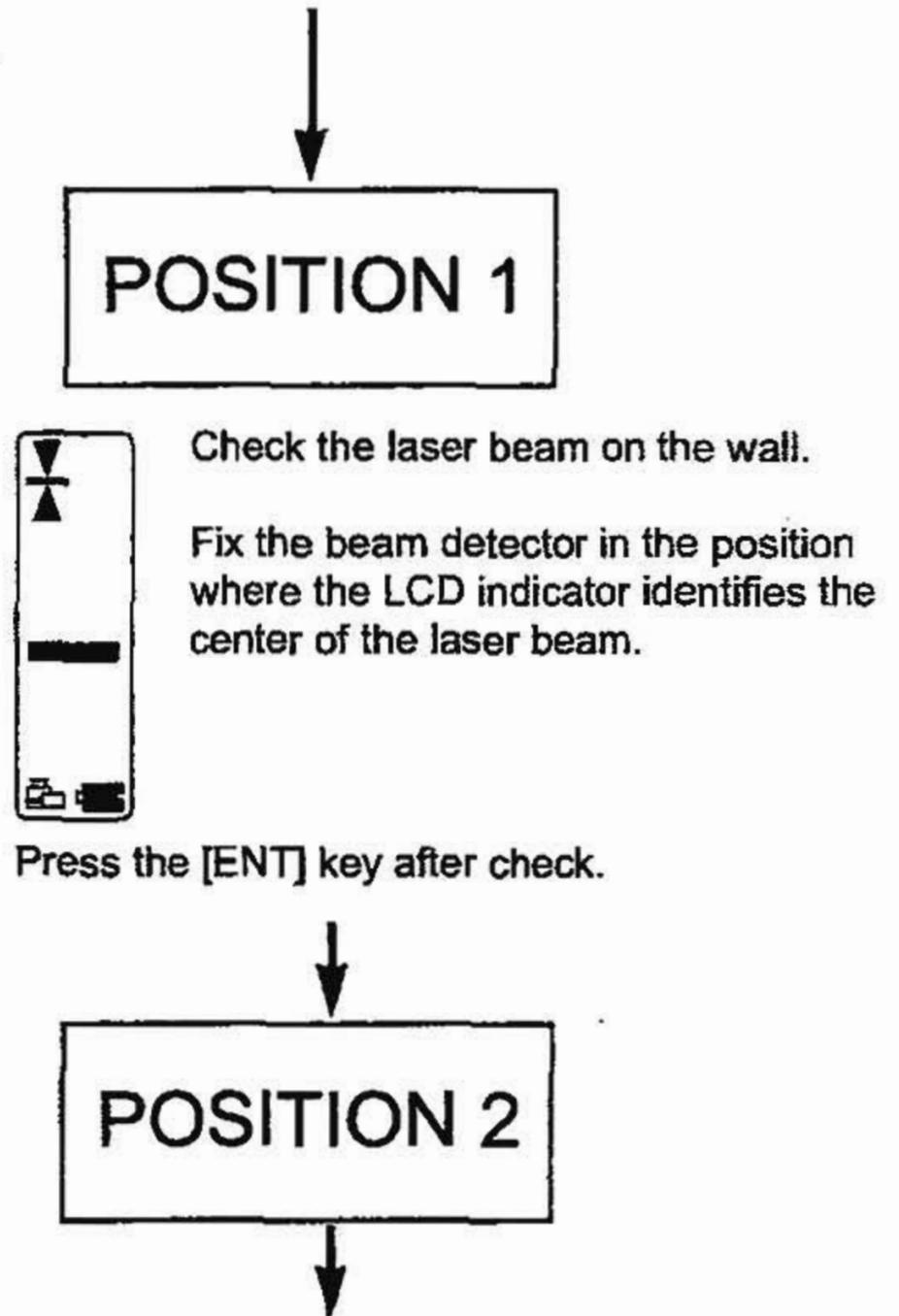

9 Loosen the tripod and rotate the instrument 180° and retighten to fix. The Y+ side of the instrument should be facing the wall. After the automatic alignment is completed, the display will change to [▲][▼], then, the rotary head rotates and emits laser beam.

10 Following step 7, mark the laser beam position for (Y+).

If the two lasers being marked are misaligned by less than 5mm, adjustment is not necessary. Turn off the power for the instrument. If adjustment is required, move on to (2) How to adjust.

(2) How to adjust

After completing the checking in step 10, go on to the adjustment specified below.

- 1 Using the arrow keys (up and down), adjust the (Y+) laser beam to the center of (Y+) and (Y-).
- 2 Press the [ENT] key when the laser beam is correctly positioned in the center.



Check the misalignment of laser beam of (Y+) and (Y-) on the wall.

If one of the 3 center indicators is lit, calibration is normal.

Misalignment of (Y-) and (Y+) laser beam within 5mm is considered normal.

Turn off the power to complete the checking.



When rotating the instrument 180°, ensure that the height of the instrument is aligned.

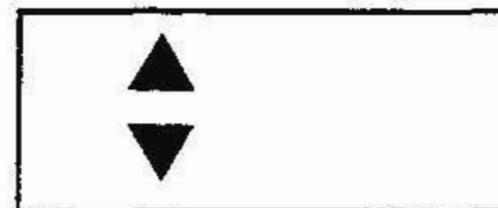

By using the up and down arrow keys of the remote controller, adjust the (Y+) laser beam to the center of the (Y-) and (Y+).

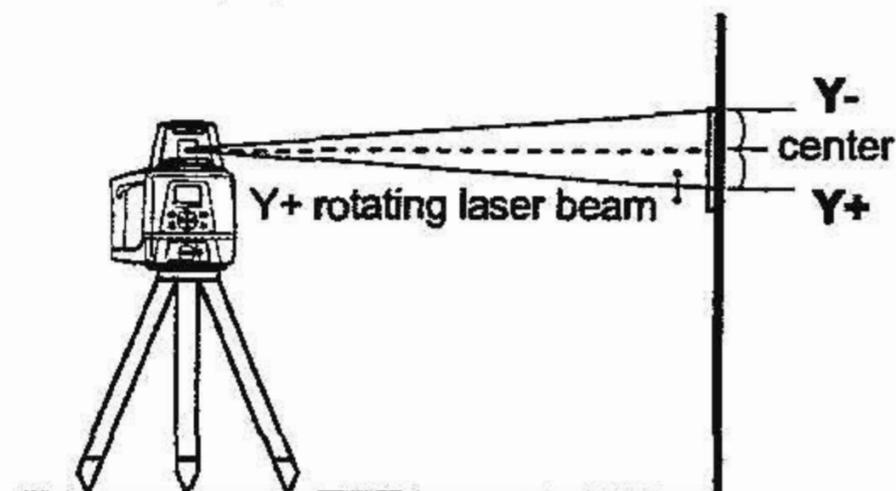

- 3 "CALCULATING" will flash indicating that the calibration value is being calculated by the instrument. Do not touch the instrument until "END" is displayed to signify operation completed. (If you touch the instrument, you will need to recalibrate.)
- 4 When "END" is displayed, press the [ENT] key. The screen will return to the axis selection screen. If you wish to continue with checking the X axis, go back to step 3 for calibration check.
- 5 When you have completed the adjustment, turn off the power. After adjustment is completed, go through the checking procedure to check if the adjustment was done accurately.

After positioning the laser beam, press the [ENT] key.

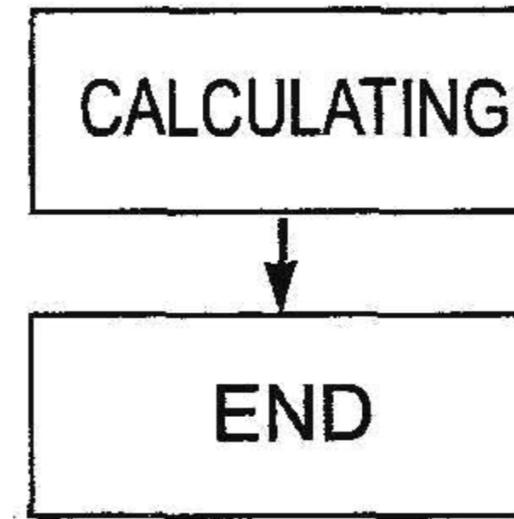

After calibration value is fixed, press the [ENT] key.

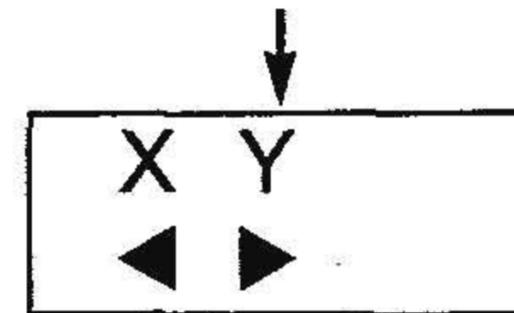

The screen goes back to the axis selection screen.



If the correction value calculated exceeds the allowable range, the SDG1 will display error code [CALIBRATION OVER ERR]. Check the procedure again and perform any inspections and adjustments.

Horizontal Rotation Cone Error

Perform the following check after completing “Horizontal Calibration” on the previous page.

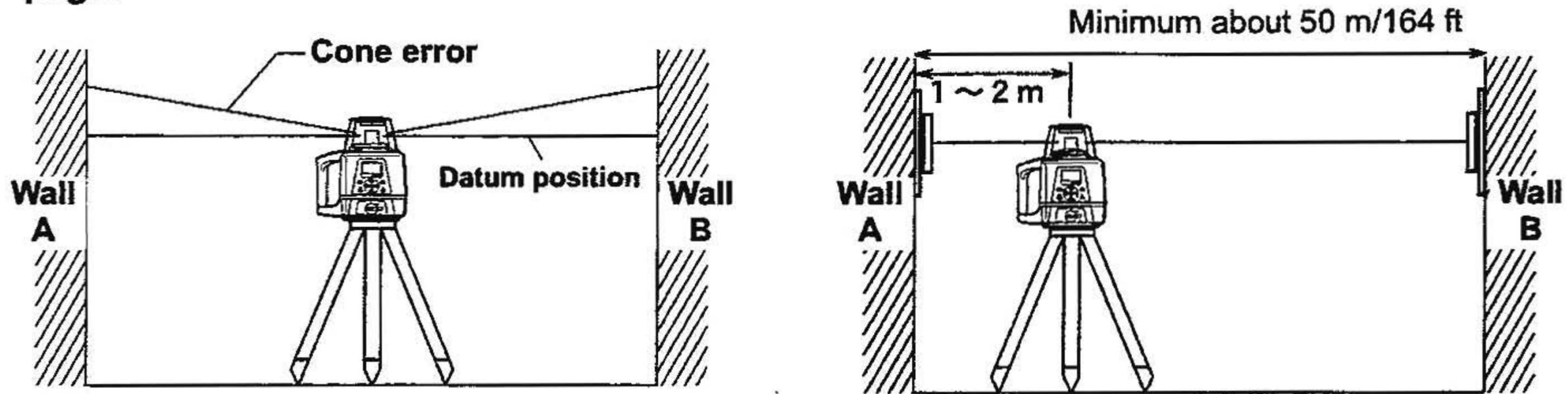

- 1 Set up the laser centered between two walls approximately 50 m (164 ft) apart. Orient the instrument so one axis, either X or Y, is facing the walls. Grade should be set to 0.00% in both axes.
- 2 Locate and mark the position of the rotating laser beam on both walls using the beam detector.
- 3 Turn off the instrument and move the instrument closer to wall A (1 m to 2 m / 3 ft to 6 ft). Do not change the axis orientation of the instrument. Turn the instrument on.
- 4 Again locate and mark the position of the rotating laser beam on both walls using the beam detector.
- 5 Measure the distance between the first and second marks on each wall.
- 6 If the difference between each set of marks is less than ± 5 mm ($\pm 7/32$ of an inch), no error exists.



If the difference between [wall A]-side and [wall B]-side exceeds ± 5 mm ($\pm 7/32$ of an inch), contact your local dealer.

Grade Setting Error

Perform the following check only after completing “Horizontal Calibration” and “Horizontal Rotation Cone Error”.

(1) Checking

1 Setup the Y+ side facing the staff as shown in the figure.

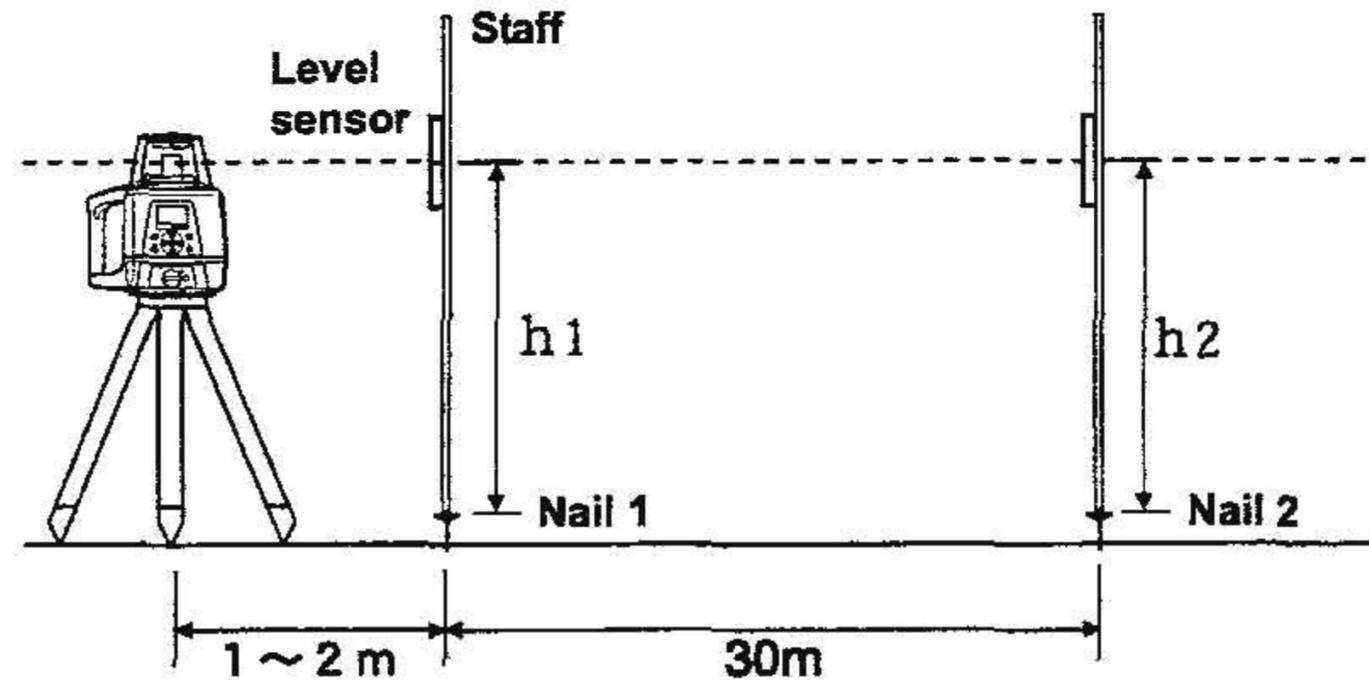

Securely position Nail 1 and Nail 2 exactly 30m apart.

2 Turn on power for the instrument and verify the staff height of Nail 1 and Nail 2 at grade setting of 0% with beam detector and record. At this time the staff height for Nail 1 and Nail 2 should be recorded as h_1 and h_2 (mm). Check the beam detector is set at high precision.

3 Set Y axis grade to 1.00%.

Align read the elevation of the laser beam in millimeters at Nail 1 and Nail 2.

Designate these elevations as "h3" at Nail 1, and "h4" at Nail 2.

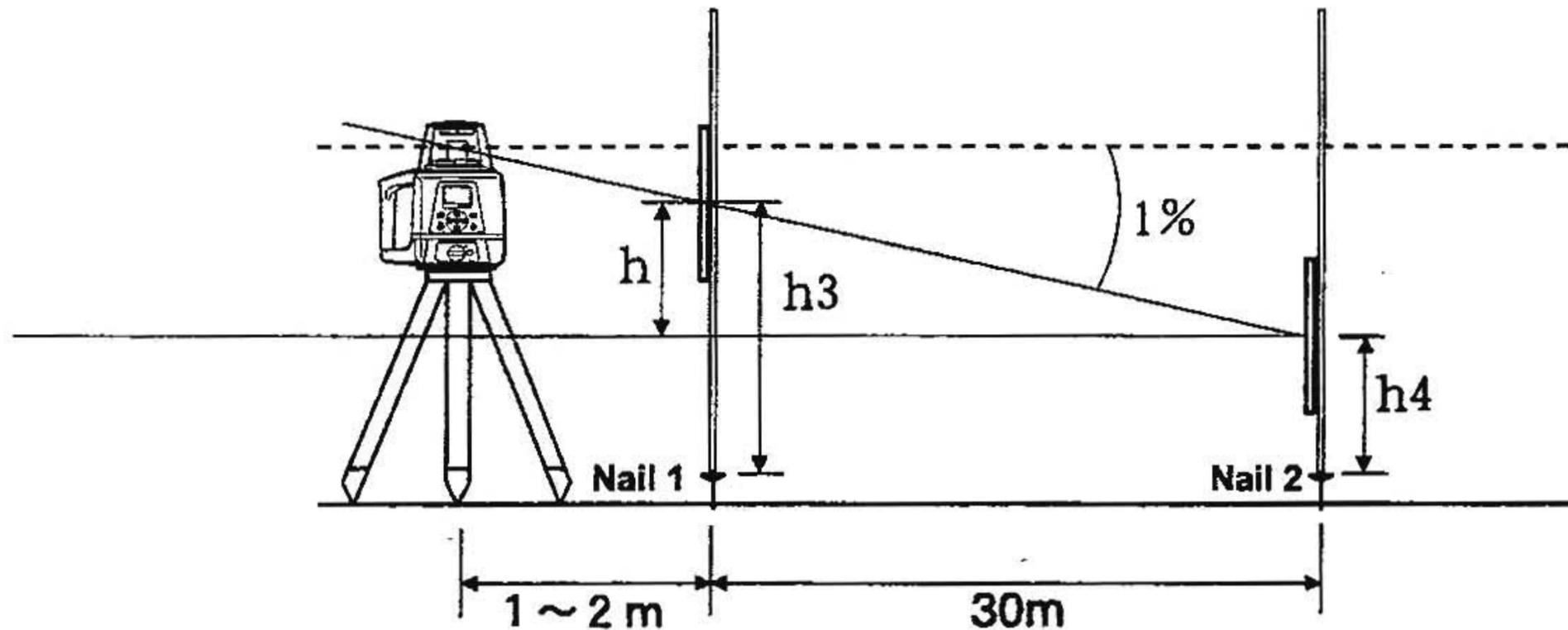

4 Using the elevation readings for h1, h2, h3 and h4, complete the equation below.

$$Y(\%) = \frac{h}{30000(\text{mm})} \times 100 = \frac{(h2 - h4) - (h1 - h3)}{30000} \times 100$$

If the calculated result is the range of 0.990% - 1.010%, the instrument is normal.

If the calculated result for either axis is out of the range, contact your local dealer.

Repeat the procedure aligning the "X" axis on the line created by Nail 1 and Nail 2.

Storage Precautions

- (1) Always clean the instrument after use.
 - 1) If the instrument got wet, wipe it well before storing in the storage case.
 - 2) Wipe away stains or dirt with a soft cloth after dusting.

- (2) Clean the carrying case using a cloth moistened with neutral detergent or water. Do not use ether, benzene, thinner or other solvents.

- (3) Store with the batteries removed, when operation is halted for more than a month.

Standard System Components

1) Instrument SDG1	1
2) Beam detector LR200.....	1
3) Remote controller LRC6	1
4) Rod clamp LPC5	1
5) Carrying case SC226	1
6) AA Manganese battery (To confirm operation)*	5
7) Operator's manual	1
8) Battery holder BDC62.....	1
9) Battery BDC63.....	1
10) AC adapter AD-11	1

• Please make sure that all of above items are in the box when you unpack.

* Batteries included in the package are to confirm the initial operation.
Please replace the batteries provided with new batteries as soon as possible.

Standard/Optional Accessories

Rod clamp LPC5

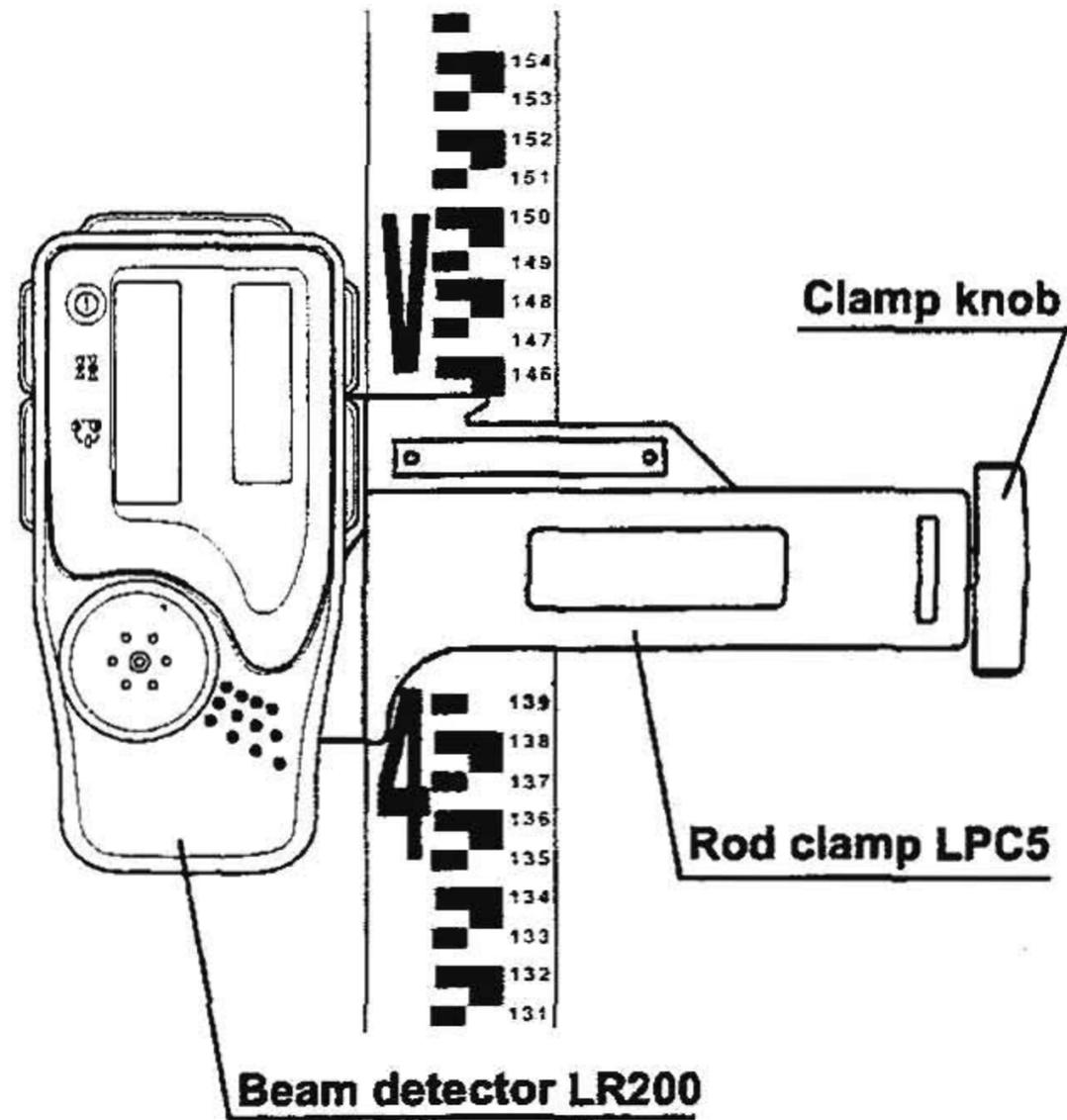

Beam detector LR200

Power switch

[Detective Beam Indication LED OFF Mode]

Pushing and holding the power switch when turning on the power will turn off the Detected Beam Indication LED. If you wish to redisplay the LED, turn on the power once again.

Precision Setting Shifting switch

Two leveling precision options are available, normal precision and high precision. By pressing this switch, the precision options are switched alternately. Confirm the precision choice by the indicator. (Normal precision is set when turning on the

Audio tone switch

(Normal / Loud / OFF)

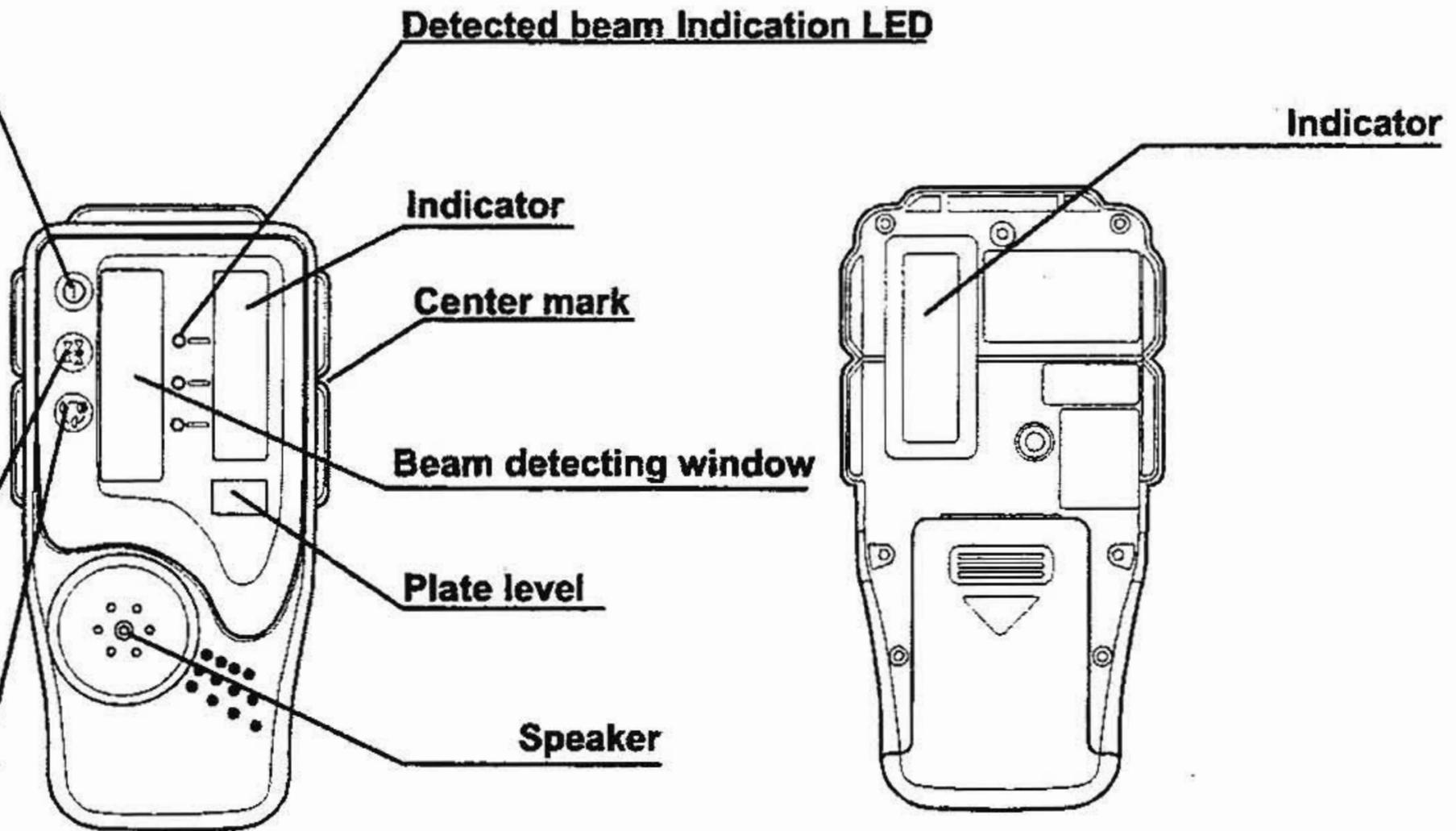

Auto power cut off function

The power will be turned off automatically if no laser beam is detected within approximately 30 minutes. (To turn the detector on again, press the power switch.)

Display

SDG1 Height Alert warning*1

When the Alert Signal function [COM] is active on the SDG1, the detector will signal if the laser has been disturbed so the height of the instrument can be checked.

The audio tone will sound for about five seconds and the height alert warning symbol will flash until the detector detects normal beam rotation from the laser. To obtain normal beam rotation, the SDG1 must be turned off then back on. Then check that beam height has not changed.

SDG1 battery warning*2

When the Alert Signal function [COM] is active on the SDG1, the detector will signal if the battery of the SDG1 is low. The laser low battery warning symbol will flash on the beam detector display. No audio tone is generated for this warning.

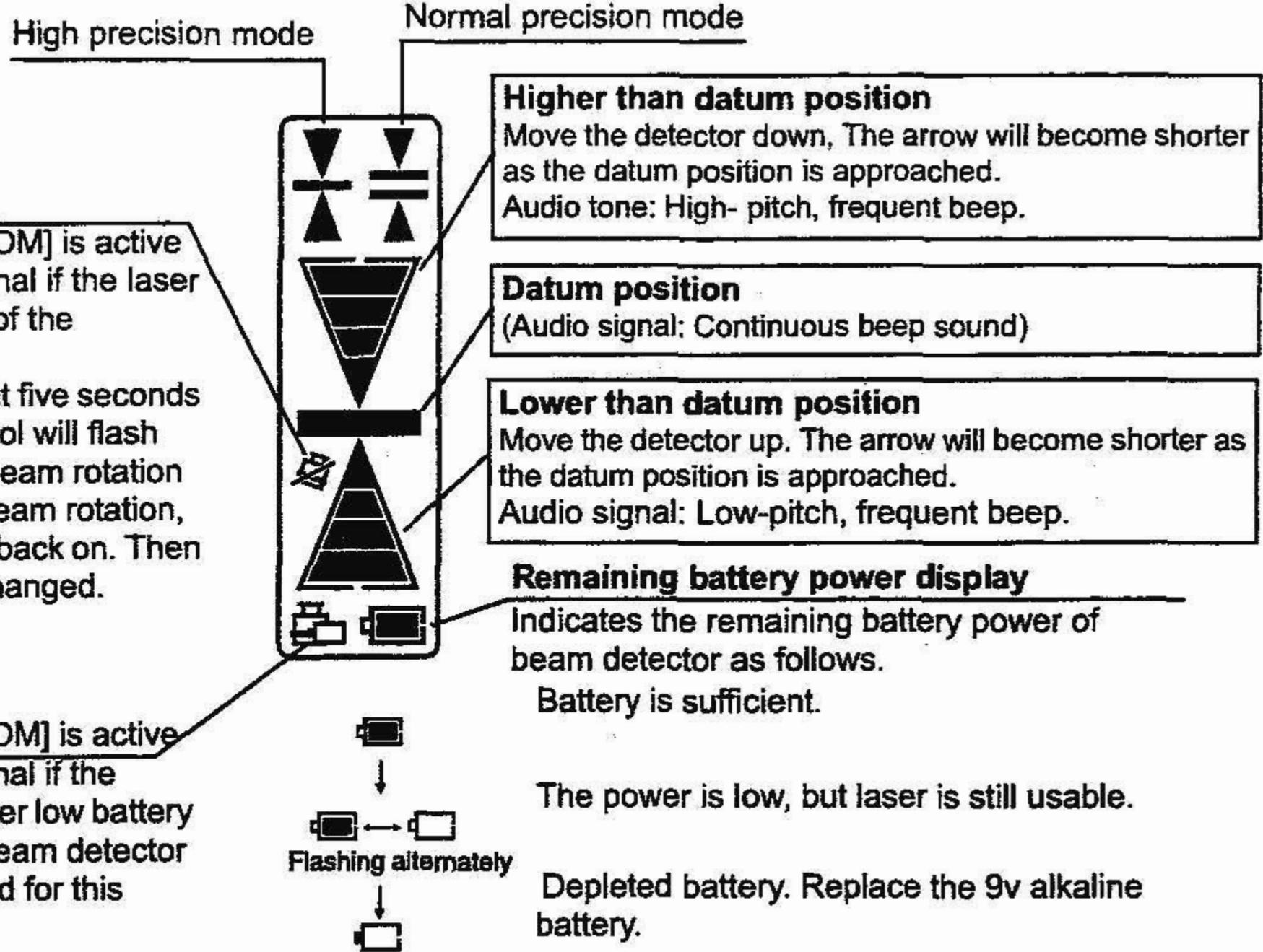

The warning signal *1 and *2 will function only if SDG1 Alert Signal function [COM] is active.

Alarm detection at the beam detector can be canceled by turning off the beam detector switch while pressing the audio tone switch. When the switch is turned back on again, alarm detection functions as usual.

Detection range

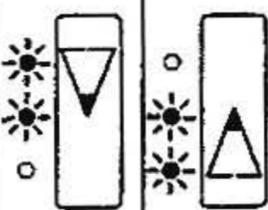
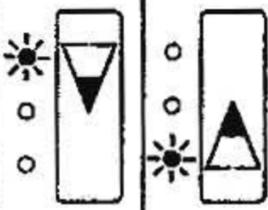
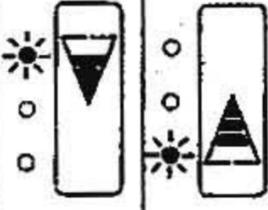
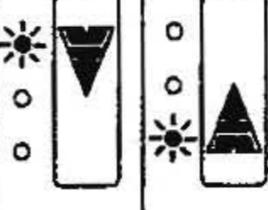
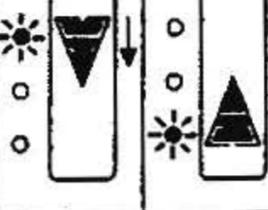
Display	Precision (LED display)
	∇ $\pm 0.5\text{mm}$ (1mm width) ∇ $\pm 2\text{mm}$ (4mm width) LED : Lights in the center
	$\pm 5\text{mm}$ (10mm width) LED : Flashes alternately
	$\pm 10\text{mm}$ (20mm width) LED : Flashes rapidly
	$\pm 15\text{mm}$ (30mm width) LED : Flashes
	more than $\pm 15\text{mm}$ (more than 30mm width) LED : Flashes slowly
	When the laser beam is off to the top or to the bottom LED : Flashes rapidly

- 1 Keep pushing the battery cover in [1] direction, and then try to slide the cover in [2] direction. The cover does not move but it will be open.
- 2 Take out the battery and place a new one into the battery box.
- 3 Press the lid down and click to close.

Replacing Battery

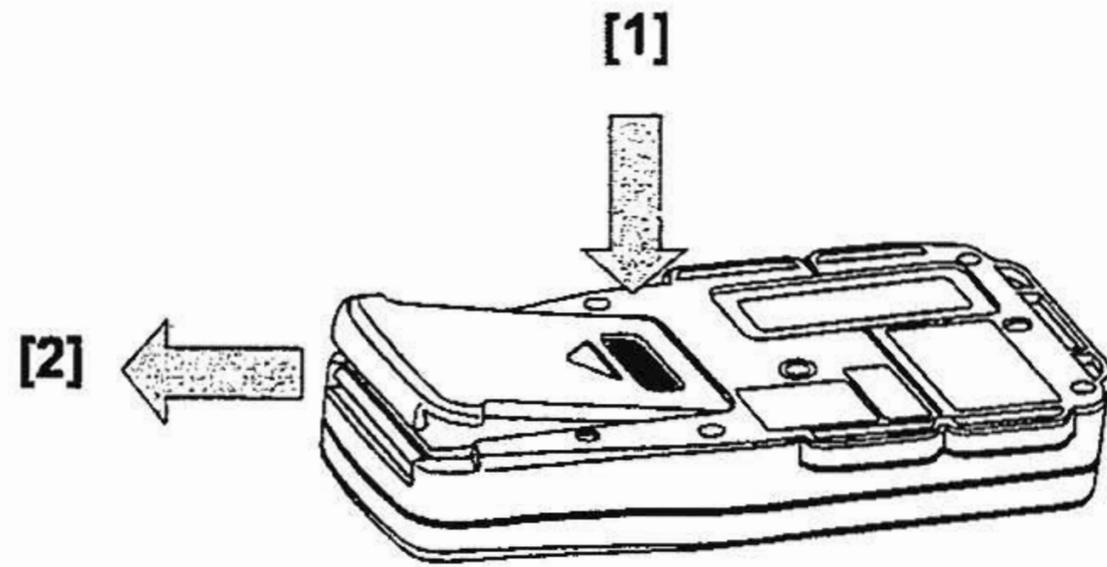

Scope Model 4

The optional scope replaces the sighting collimator (see page 24) on top of the instrument and provides greater accuracy in aligning the laser to the direction of grade. The scope can be swiveled and locked in place so its aimed toward any of the four beam axes. Using the scope, follow the steps on page 24 to align the instrument.

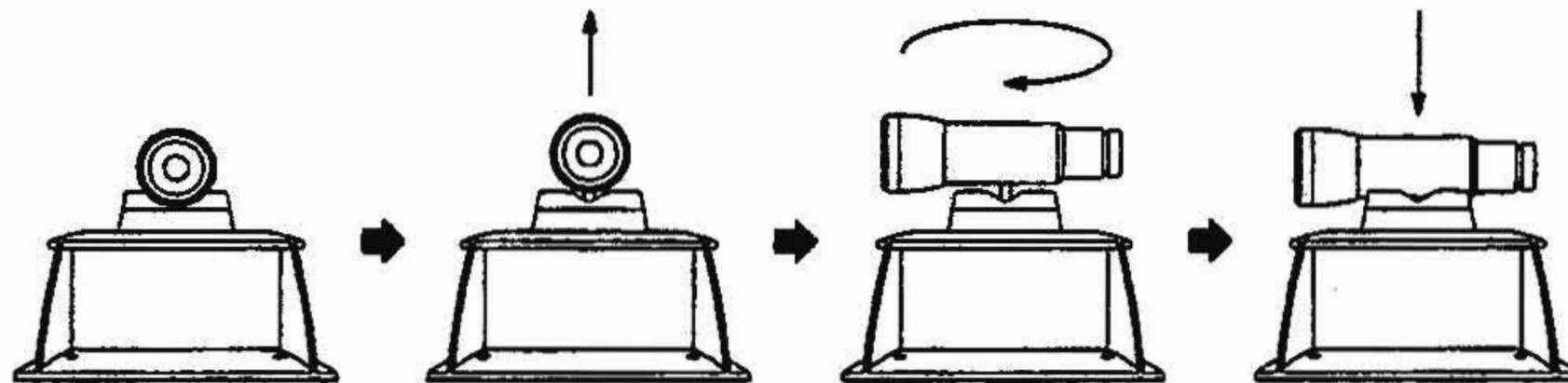

Specifications

SDG1

Accuracy	: ±10"
Self-leveling range	: ±5°
Measuring range (Diameter)	: Approx. 2 – 800 m (6 - 2624.7 ft) with beam detector
Rotation speeds	: 300/600/900 rpm (Changeable)
Light source	: Laser diode (Visible laser)
Power supply	: 4D-CELL dry batteries (VDC 6) Ni-MH battery pack BDC63 (It can be charged while using)
Continuous operating time	Alkaline manganese dry battery : Approx. 85 hours Ni-MH battery pack BDC63 : Approx. 80 hours
Tripod screw	: Flat and dome head type, 5"/8X11threads
Dust and water resistance	: IP66 (IEC 60529:2001)
Operating temperature	: -20 °C to +50 °C (-4 °F to +122 °F)
Dimensions	: 174 (L) × 218 (W) × 253 (H) mm [6.9 (L) × 8.6 (W) × 10.0 (H) in]
Weight	: 3.4kg (7.5lbs) (Dry battery type: Including dry batteries) 3.6kg (7.9lbs) (Ni-MH battery type: Including BDC63)

LRC6

Power source	: Three AAA cell batteries
Operating distance	: Approx. 300m
Continuous operating time	: Approx. 3 months (Alkaline manganese dry battery) (Life of battery may significantly shorten in cold regions)
Operating temperature	: -20 °C to +50 °C (-4 °F to +122 °F)
Dimensions	: 157 (L) × 64 (W) × 37 (H) mm [6.8 (L) × 2.5 (W) × 1.4 (H) in]
Weight	: 0.25kg (0.5lbs) (Including dry batteries)

LR200 (Back side display area / Audio tone / LED / Plate level)

Detection range : 50 mm (2.0 in)

Detection precision

High precision: ± 0.5 mm (± 0.02 in)

Normal precision: ± 2 mm (± 0.08 in)

Detective beam indication

: Liquid crystal (Both sides) / Audio tone / LED

Power supply : Two AA dry batteries

Power voltage : 3 VDC

Continuous operating time

Alkaline manganese dry battery

: Approx. 100 hours

Auto Power Cut Off Function

: Yes

Dust and water resistance

: IP66 (IEC 60529:2001)

Operating temperature

: -20 °C to $+50$ °C (-4 °F to $+122$ °F)

Dimensions : 146 (l) × 76 (w) × 26 (h) mm

: 5.7 (l) × 2.9 (w) × 1.0 (h) in)

Weight : 0.19 kg (0.41 lbs)

(including dry batteries)

Error Display

Error Code	Description	Countermeasure
 SDG1 BATTERY LOW	Batteries of the instrument are depleted.	Replace the batteries of the instrument.
 LRC6 BATTERY LOW	Batteries of the remote controller are depleted.	Replace the batteries of the remote controller.
	Safety lock system is activated.	Turn the power for the instrument off, and then turn it back on to activate automatic alignment function.
	The instrument is set up in excess of the alignment range.	Reposition the instrument within the alignment range in the direction specified.
		
		
		
CALIBRATION OVER ERR	Checking mode identified as exceeding calibration range.	Turn the power for the instrument; turn it back on and start over from the beginning.
E-05	The rotary head is not rotating	Turn the power for the instrument off, and then turn it back on.

Error Code	Description	Countermeasure
E-51	Internal memory error for the remote controller	Turn the power for the remote controller off, and then turn it back on.
E-60's	Encoder system error for the instrument	Turn the power for the instrument off, and then turn it back on.
E-80's	Alignment is not completed	Turn the power for the instrument off, and then turn it back on.
E-99	Internal memory error for the instrument	Turn the power for the instrument off, and then turn it back on.
LCD backlight is flashing	Cannot be displayed	Turn the power for the instrument off, and then turn it back on.

If errors still persist after attempting to clear them, contact your local dealer.

Regulations

For users in the US

WARNING: Changes or modifications not expressly approved by the manufacturer for compliance could void the user's authority to operate the equipment.

NOTE: This device complies with Part 15 of the FCC Rules. Operation is subject to the following two conditions: (1) this device may not cause harmful interference, and (2) this device must accept any interference received, including interference that may cause undesired operation.

These limits are designed to provide reasonable protection against harmful interference when the equipment is operated in a commercial environment. This equipment generates, uses, and can radiate radio frequency energy and, if not installed and used in accordance with the instruction manual, may cause harmful interference to radio communications. Operation of this equipment in a residential area is likely to cause harmful interference in which case the user will be required to correct the interference at his own expense.

CHANGES OR MODIFICATIONS NOT EXPRESSLY APPROVED BY THE MANUFACTURER FOR COMPLIANCE COULD VOID THE USER'S AUTHORITY TO OPERATE THE EQUIPMENT

CAUTION: This device and its antenna(s) must not be co-located or operating in conjunction with any other antenna or transmitter. End user cannot modify this transmitter device. Any unauthorized modification made on the device could void the user's authority to operate this device.

The following sentence has to be displayed on the outside of the device in which the transmitter module is installed:

“Contains FCC ID: PH3XE972

WARNING : Handling the cord on this product or cords associated with accessories sold with this product, will expose you to lead, a chemical known to the State of California to cause birth defects or other reproductive harm. *Wash hands after handling.*

For users in Canada

This Class B digital apparatus meets all requirements of Canadian Interference-Causing Equipment Regulations.

Cet appareil numérique de la Class B respecte toutes les exigences du Règlement sur le matériel brouilleur du Canada.

This class B digital apparatus complies with Canadian ICES-003.

Cet appareil numérique de la Class B est conforme a la norme NMB-003 du Canada.

The term “IC:” before the radio certification number only signifies that Industry Canada technical specifications were met.

“Operation is subject to the following two conditions:

- (1) this device may not cause interference, and
- (2) this device must accept any interference, including interference that may cause undesired operation of the device.”

“The installer of this radio equipment must ensure that the antenna is located or pointed such that it does not emit RF field in excess of Health Canada limits for the general population; consult Safety Code 6, obtainable from Health Canada’s website www.hc-sc.gc.ca/rpb”

The following sentence has to be displayed on the outside of the device in which the transmitter module is installed:

“Contains IC: 3070C-XE972

“This device has been designed to operate with the antennas listed below, and having a maximum gain of 0.61 dB. Antennas not included in this list or having a gain greater than 0.61 dB are strictly prohibited for use with this device. The required antenna impedance is 50 ohms.”

“To reduce potential radio interference to other users, the antenna type and its gain should be so chosen that the equivalent isotropically radiated power (e.i.r.p.) is not more than that permitted for successful communication.”

For users in the European Economic Area (EEA)



EMC NOTICE
In industrial locations or in proximity to industrial power installations, this instrument might be affected by electromagnetic noise. Under such conditions, please test the instrument performance before use.

CE Conformity Declaration
in accordance with EMC Directive 2004/108/EC and R&TTE Directive 1999/5/EC
of the European Community

We herewith declare that the undermentioned instrument, in view of its design and type of construction, fully complies with the relevant basic radio interference requirements of the EMC and R&TTE Directive.

Should the instrument be modified without agreement, this declaration becomes invalid.

Instrument Description: **Dual Grade Laser**

Model Name : **SDG1**

Relevant EC Directive: **EMC Directive (2004/108/EC)**
R&TTE Directive (99/5/EC)

Applied

Harmonized Standard:	R&TTE	EN50371 : 2002	
		EN300 440-1 : 2001	-2 : 2004
	EMC	EN301 489-1 : 2004	-3 : 2002
		Class B	
	LVD	EN60950-1 : 2001	

The SDG1 is an OEM product based on the RL-1002S manufactured by Topcon Corporation.

Date: June 27, 2008

Firm: SOKKIA B.V.

Address: Industrieterrein De Vaart, Damsluisweg 1, NI-1332 EA Almere

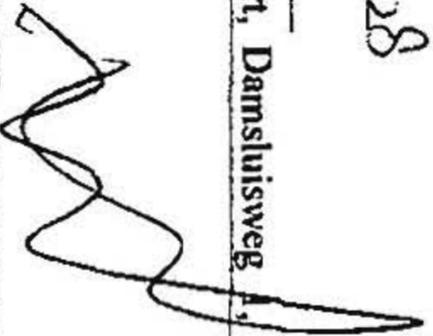
Representative's Signature: _____

Name of Representative : **Gerben Wolsink**

Representative's position : **European Service Manager**

SOKKIA TOPCON CO., LTD.

<http://www.sokkia.co.jp/english/>

260-63 HASE, ATSUGI, KANAGAWA, 243-0036 JAPAN

2nd ed. 03-0911 (31390 90042)

©SOKKIA TOPCON CO., LTD.